

Linked Lists

Part One

Outline for Today

- ***Linked Lists, Conceptually***
 - A different way to represent a sequence.
- ***Linked Lists, In Code***
 - Some cool new C++ tricks.

Changing Offices

The Sign on Gates 100

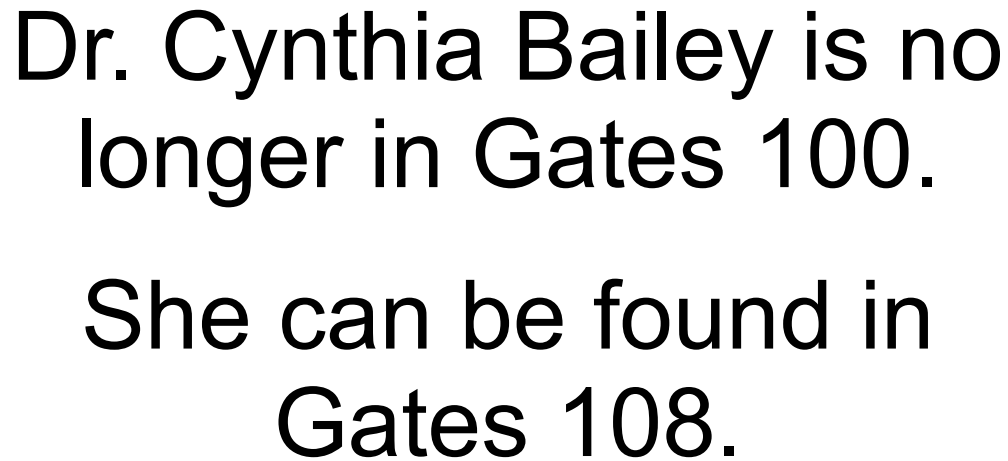

Dr. Cynthia Bailey is no longer in Gates 100.
She can be found in Gates 108.

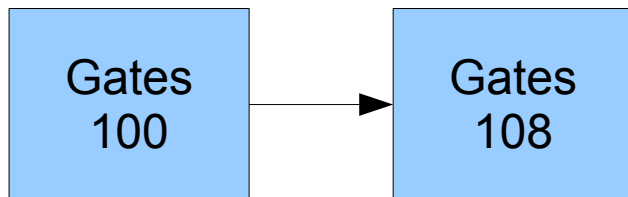

The Sign on Gates 108

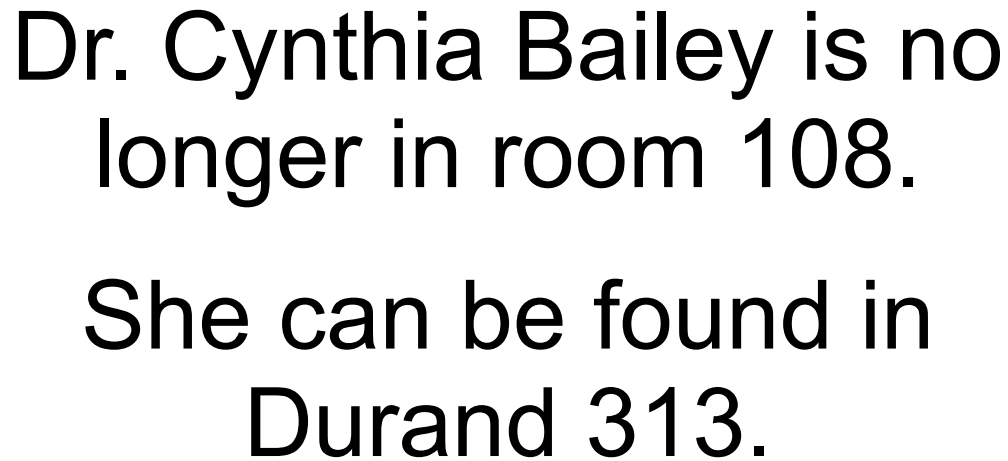

Dr. Cynthia Bailey is no longer in room 108.
She can be found in Durand 313.

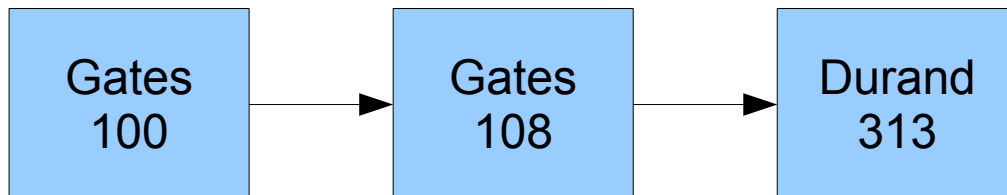

The Sign on Gates 190

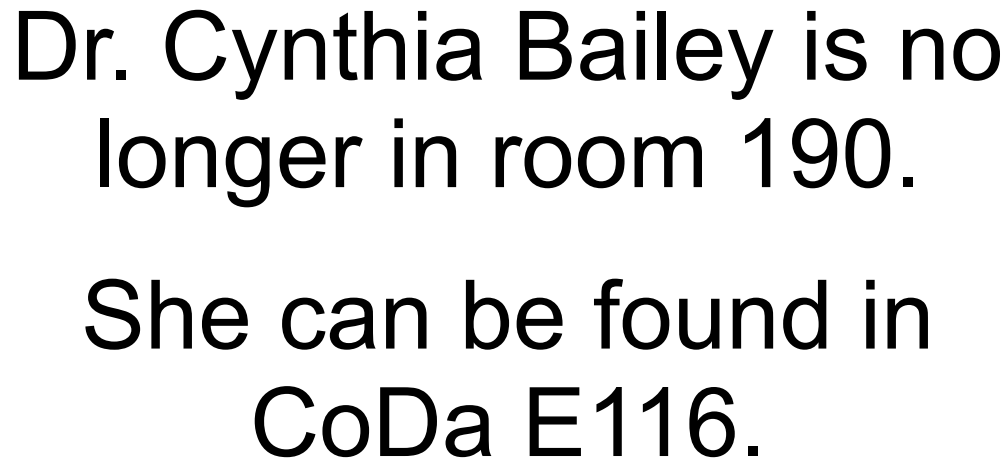

Dr. Cynthia Bailey is no longer in room 190.
She can be found in CoDa E116.

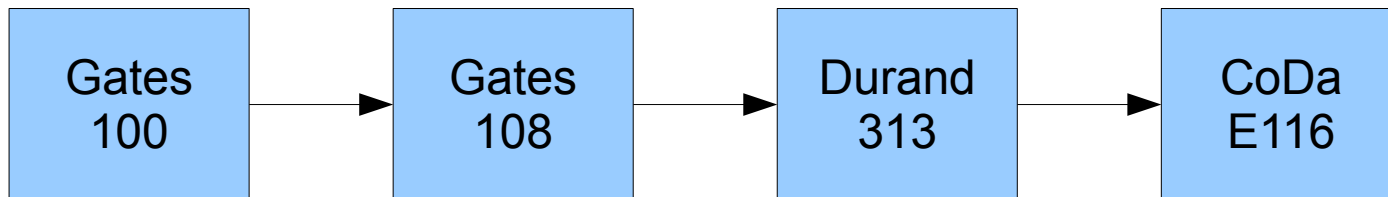

The Sign on CoDa E116



Welcome to Cynthia's
Office!

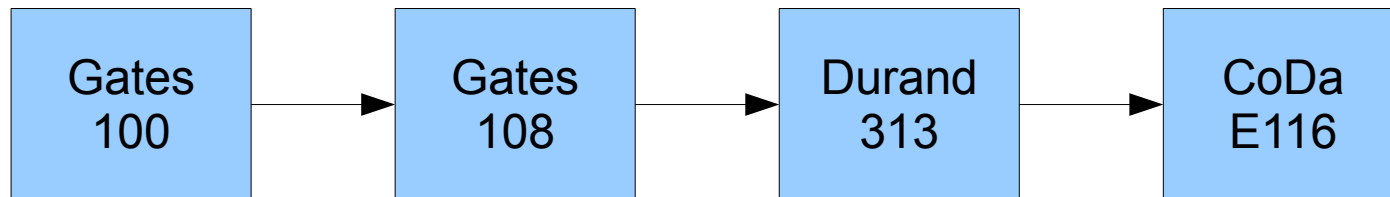

Linked Lists at a Glance

- A ***linked list*** is a data structure for storing a sequence of elements.
- Each element is stored separately from the rest.
- The elements are then chained together into a sequence.
- The end of the list is marked with some special indicator.

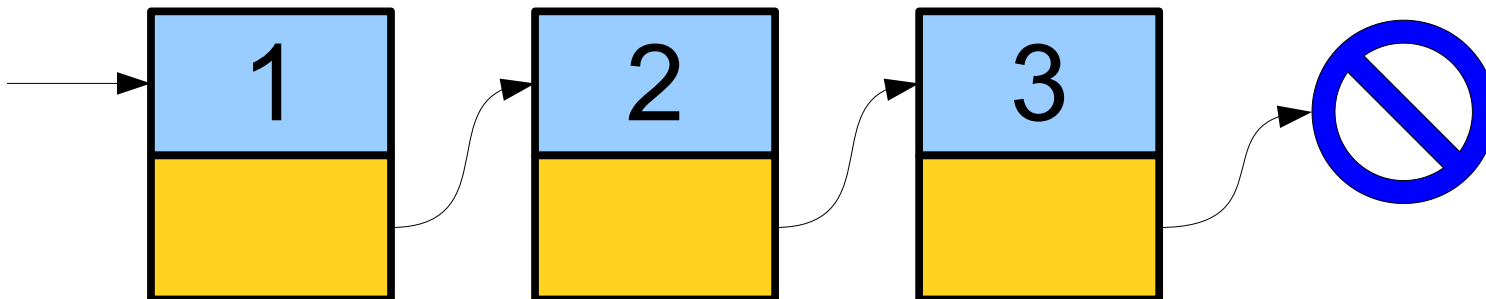

Linked Lists at a Glance

- A ***linked list*** is a data structure for storing a sequence of elements.
- Each element is stored separately from the rest.
- The elements are then chained together into a sequence.
- The end of the list is marked with some special indicator.

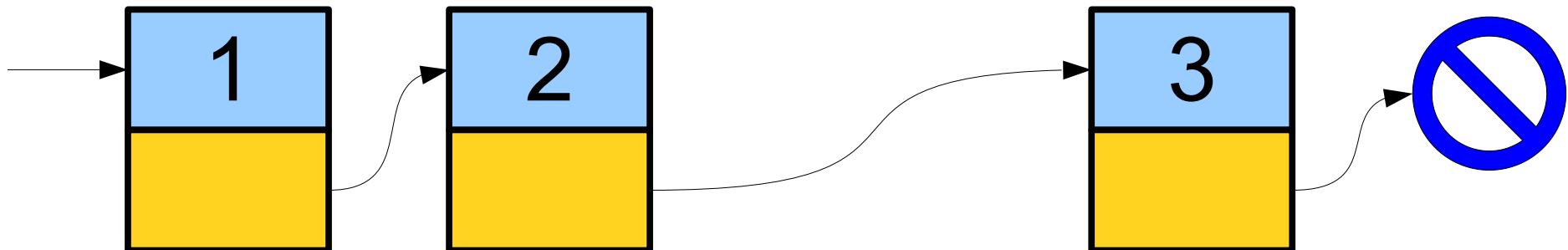

Linked Lists at a Glance

- A **linked list** is a data structure for storing a sequence of elements.
- Each element is stored separately from the rest.
- The elements are then chained together into a sequence.
- The end of the list is marked with some special indicator.

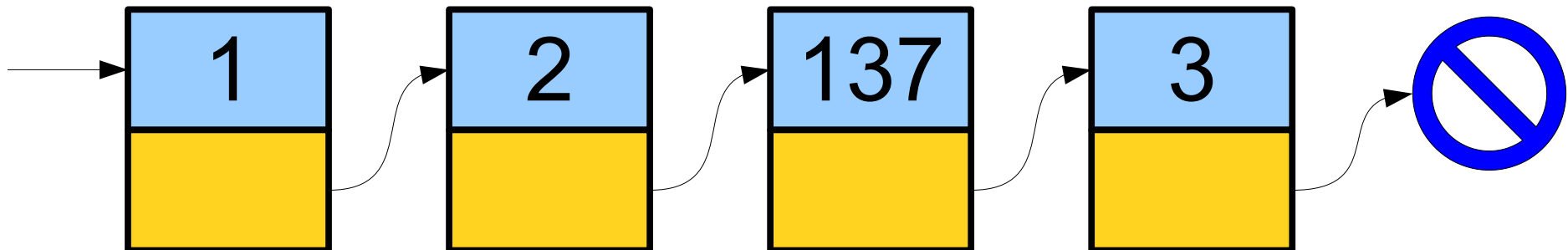

Linked Lists at a Glance

- A **linked list** is a data structure for storing a sequence of elements.
- Each element is stored separately from the rest.
- The elements are then chained together into a sequence.
- The end of the list is marked with some special indicator.

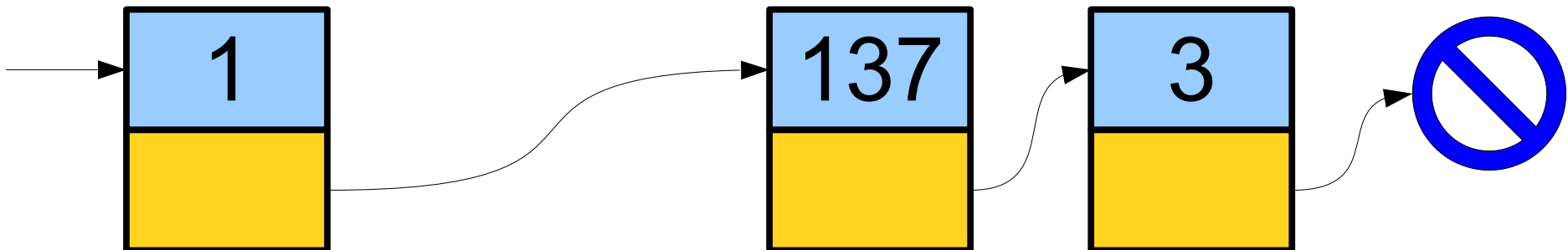

A Linked List is Either...

...an empty list,
or...

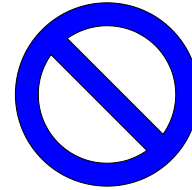

a single cell...

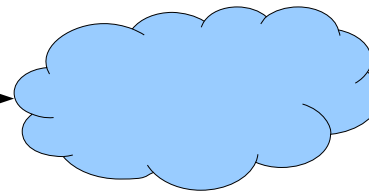

... that points at
another linked list.

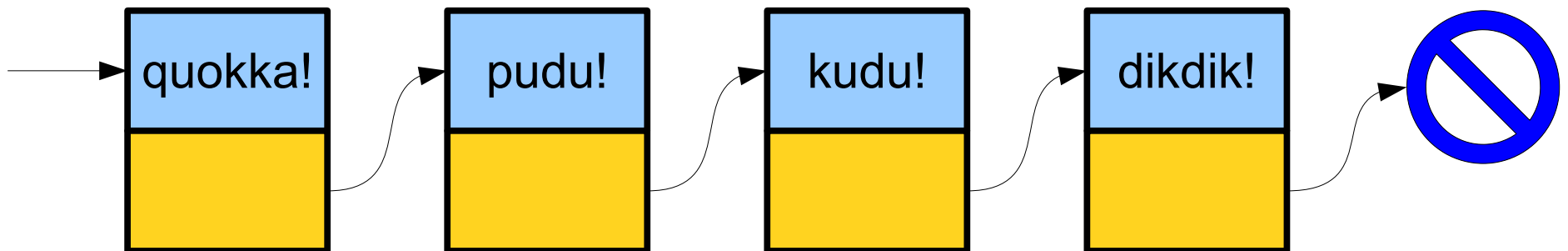

Representing Linked Lists

A Linked List is Either...

...an empty list,
or...

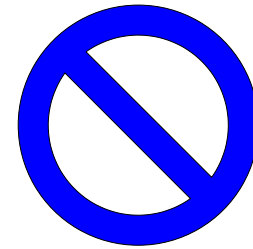

a single cell...

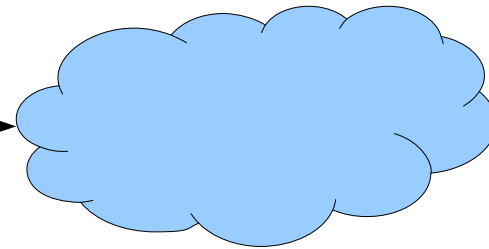

... that points at
another linked list.

A Linked List is Either...

...an empty list,
or...

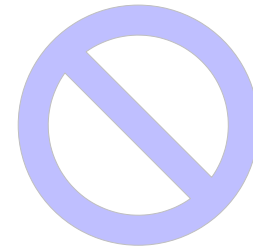

a single cell...

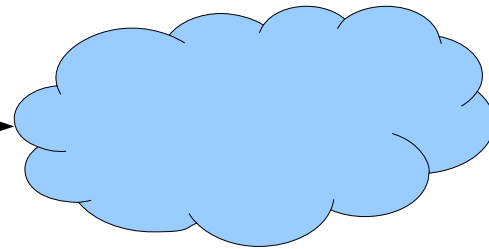

... that points at
another linked list.

```
struct Cell {  
    string value;  
    Cell* next;  
};
```

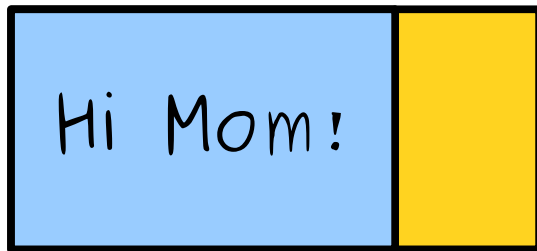

a single cell...

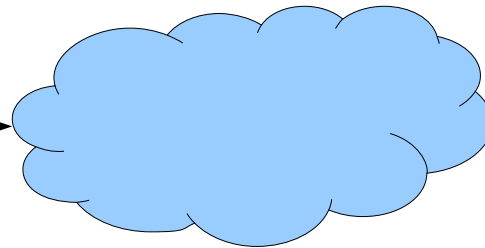

... that points at
another linked list.

```
struct Cell {  
    string value;  
    Cell* next;  
};
```

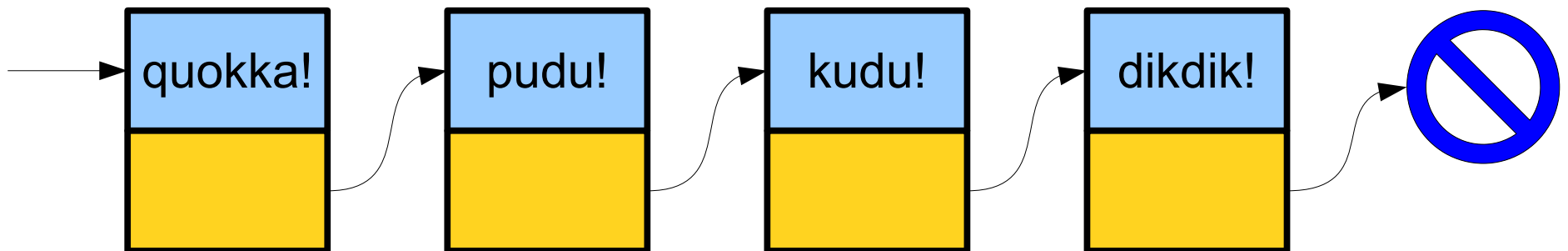

```
struct Cell {  
    string value;  
    Cell* next;  
};
```

```
Cell* list = new Cell;
```

We just want a single cell, not an array of cells. To get the space we need, we'll just say **new** Cell.

Notice that list is still a Cell*, a pointer to a cell. It still says "look over there for your Cell" rather than "I'm a Cell!"

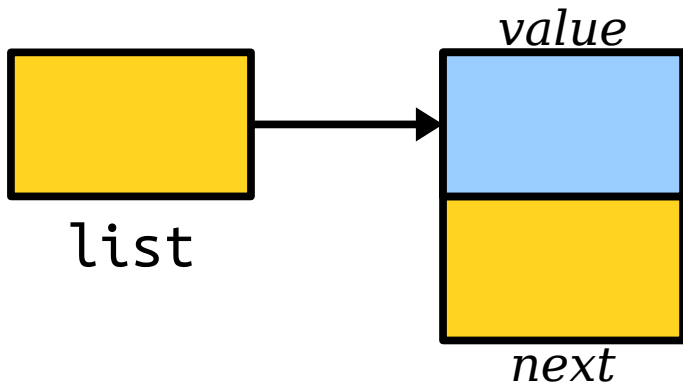

Yes, it's confusing that C++ uses the same types to mean "look over there for an array of Cells" and "look over there for a single Cell."

```
struct Cell {  
    string value;  
    Cell* next;  
};
```

```
Cell* list = new Cell;  
list->value = "pudu!";
```

Because list is a pointer to a Cell, we use the arrow operator -> instead of the dot operator.

Think of list->value as saying "start at list, follow an arrow, then pick the value field."

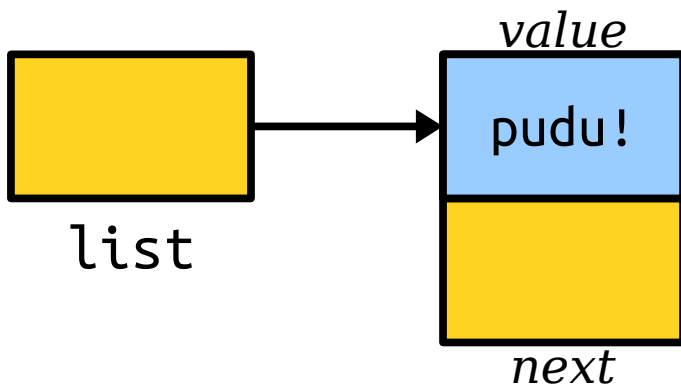

```
struct Cell {  
    string value;  
    Cell* next;  
};
```

```
Cell* list = new Cell;  
list->value = "pudu!";  
list->next = new Cell;  
list->next->value = "quokka!";  
list->next->next = new Cell;  
list->next->next->value = "dikdik!";  
list->next->next->next = nullptr;
```

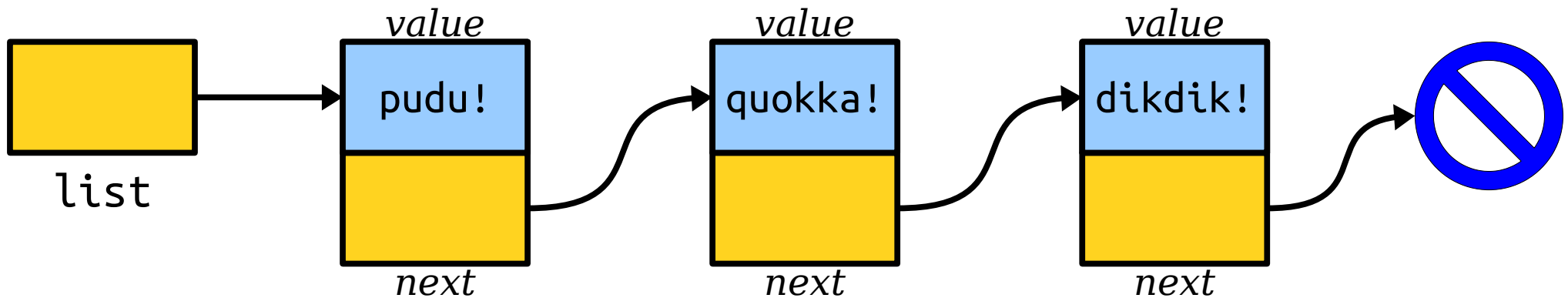

```
struct Cell {  
    string value;  
    Cell* next;  
};
```

```
Cell* list = new Cell;  
list->value = "pudu!";  
list->next = new Cell;  
list->next->value = "quokka!";  
list->next->next = new Cell;  
list->next->next->value = "dikdik!";  
list->next->next->next = nullptr;
```

C++ uses the **nullptr** keyword to mean "a pointer that doesn't point at anything."

(Older code uses NULL instead of **nullptr**; that's also okay, but we recommend **nullptr**.)

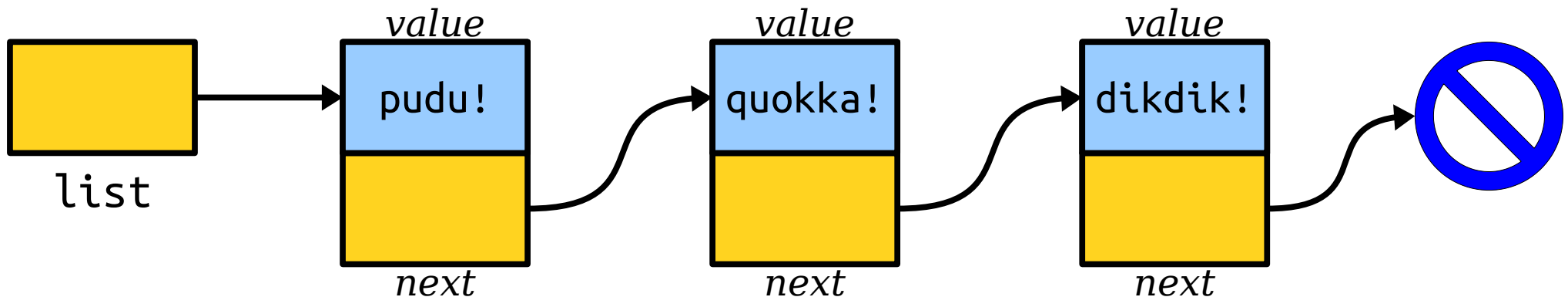

A Linked List is Either...

...an empty list,
represented by
nullptr, or...

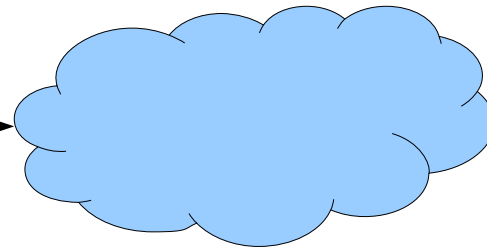
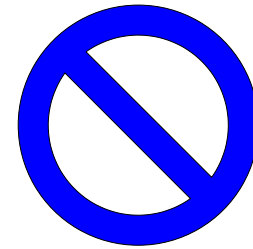

a single linked list
cell that points...

... at another linked
list.

Measuring a Linked List

A Linked List is Either...

...an empty list,
represented by
nullptr, or...

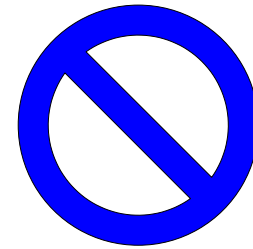

a single linked list
cell that points...

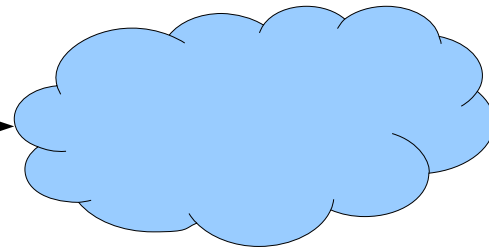

... at another linked
list.

A Linked List is Either...

...an empty list,
represented by
nullptr, or...

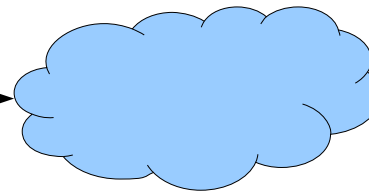
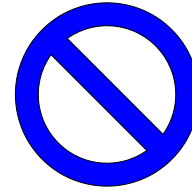

a single linked list
cell that points...

... at another linked
list.

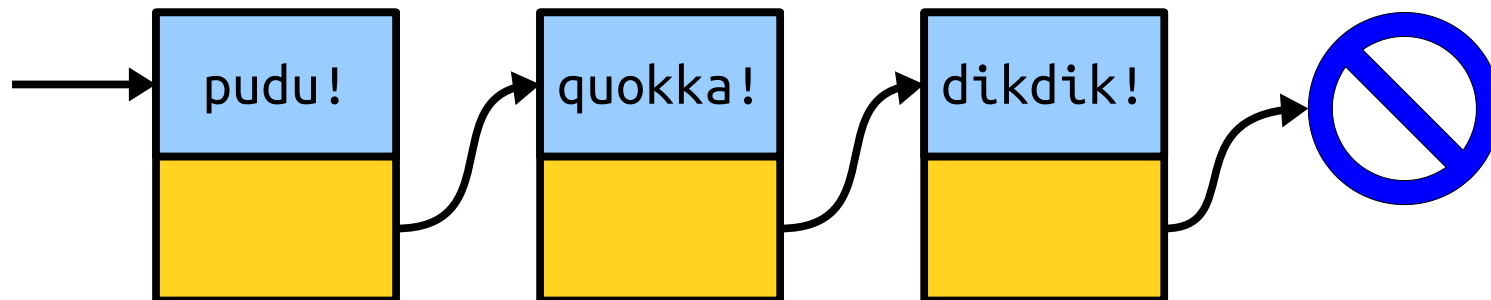

Printing a Linked List

A Linked List is Either...

...an empty list,
represented by
nullptr, or...

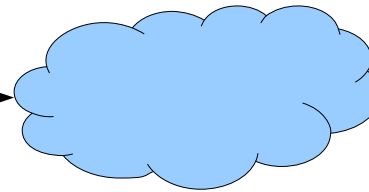
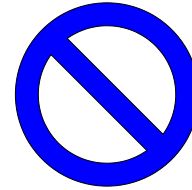

a single linked list
cell that points...

... at another linked
list.

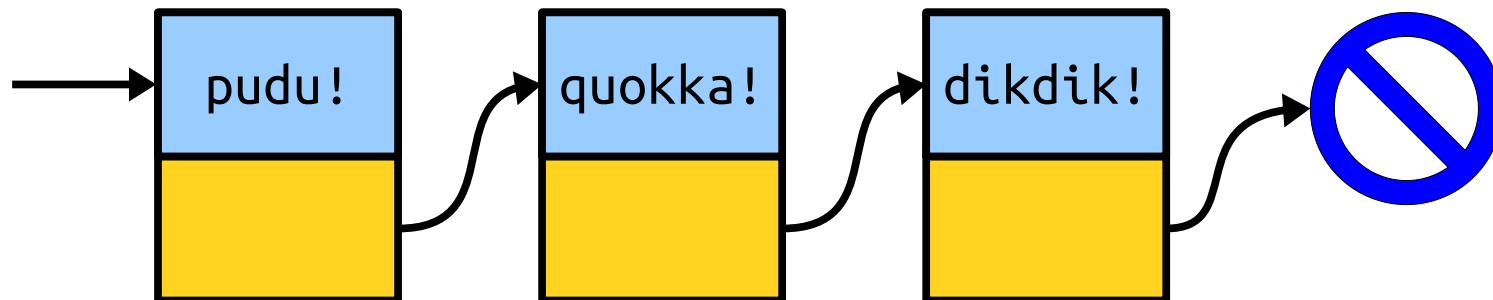

```
int main() {  
    Cell* list = /* ... a list ... */;  
    printList(list);  
  
    /* ... other listy things. ... */  
}
```

```
int main() {  
    Cell* list = /* ... a list ... */;  
    printList(list);  
  
    /* ... other listy things. ... */  
}
```

```
int main() {  
    Cell* list = /* ... a list ... */;  
    printList(list);  
  
    /* ... other listy things. ... */  
}
```

list

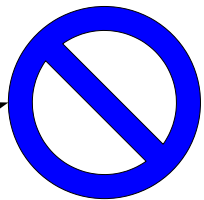
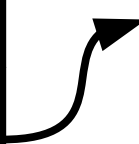
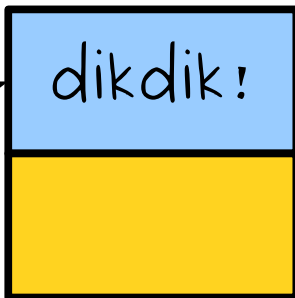
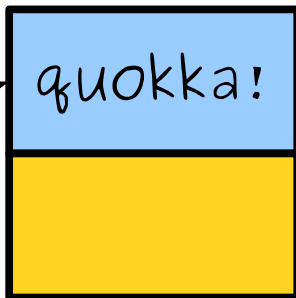
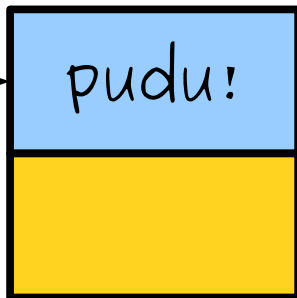

```
int main() {  
    Cell* list = /* ... a list ... */;  
    printList(list);  
  
    /* ... other listy things. ... */  
}
```

list

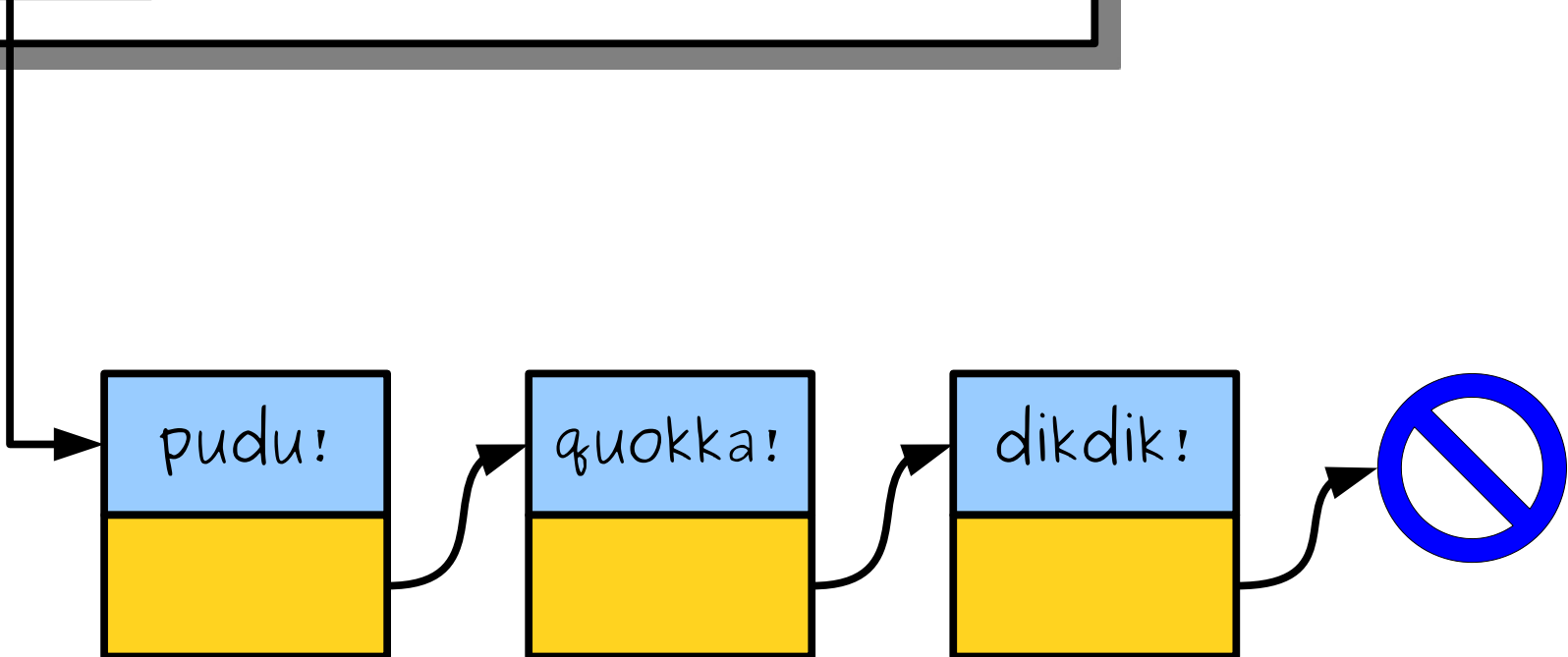

```
int main() {  
    Cell* list = /* ... a list ... */;  
    printList(list);  
  
    /* ... other listy things. ... */  
}
```

list

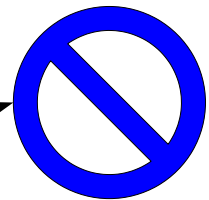
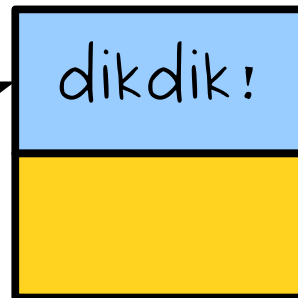
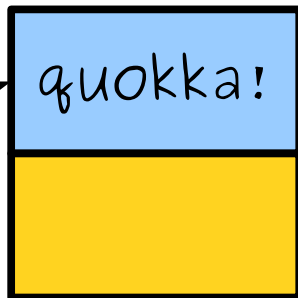
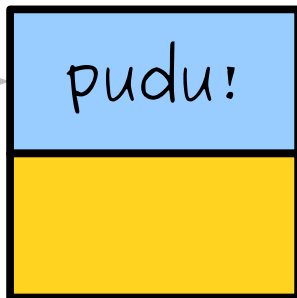

```
int main() {
```

```
void printList(Cell* list) {  
    while (list != nullptr) {  
        cout << list->value << endl;  
        list = list->next;  
    }  
}
```

list

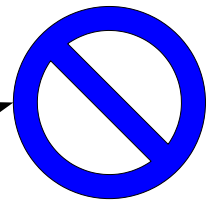
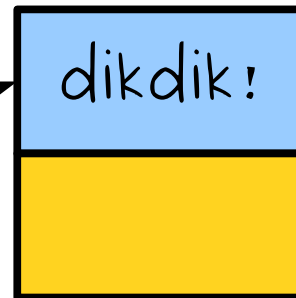
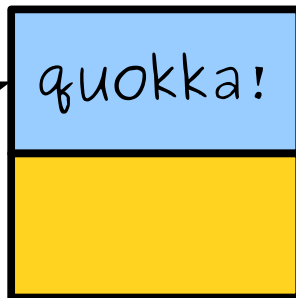
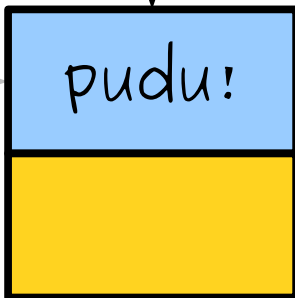

```
int main() {
```

```
void printlist(Cell* list) {
```

```
while (list != nullptr) {
```

```
    cout << list->value << endl;
```

```
    list = list->next;
```

```
}
```

```
}
```

list

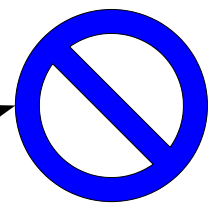
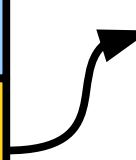
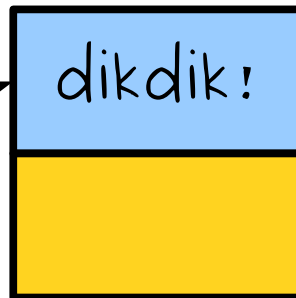
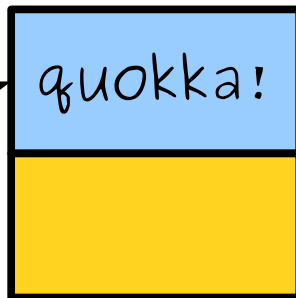
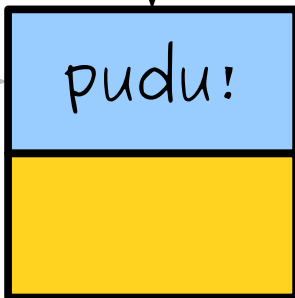

```
int main() {
```

```
void printList(Cell* list) {  
  while (list != nullptr) {  
    cout << list->value << endl;  
    list = list->next;  
  }  
}
```

list

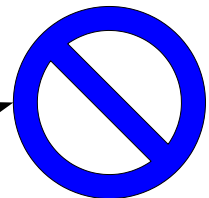
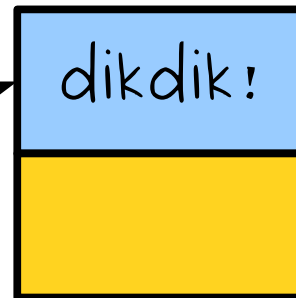
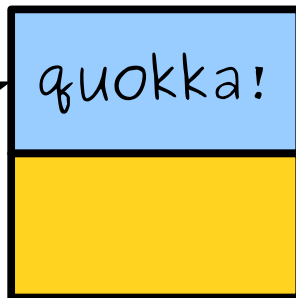
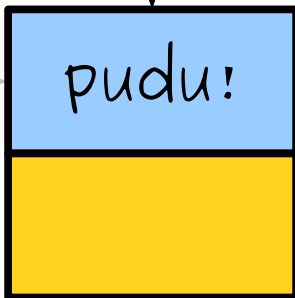

```
int main() {
```

```
void printList(Cell* list) {  
    while (list != nullptr) {  
        cout << list->value << endl;  
        list = list->next;  
    }  
}
```

list

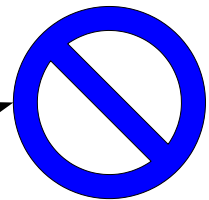
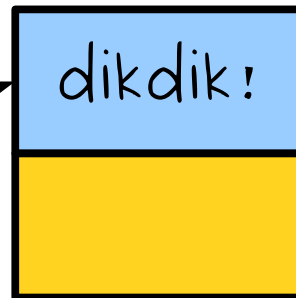
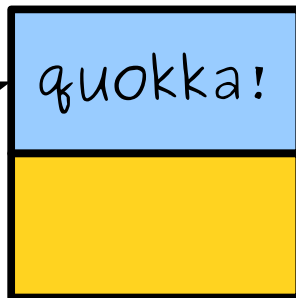
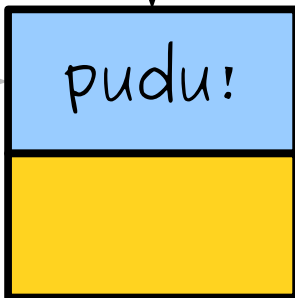

```
int main() {  
    void printList(Cell* list) {  
        while (list != nullptr) {  
            cout << list->value << endl;  
            list = list->next;  
        }  
    }  
}
```

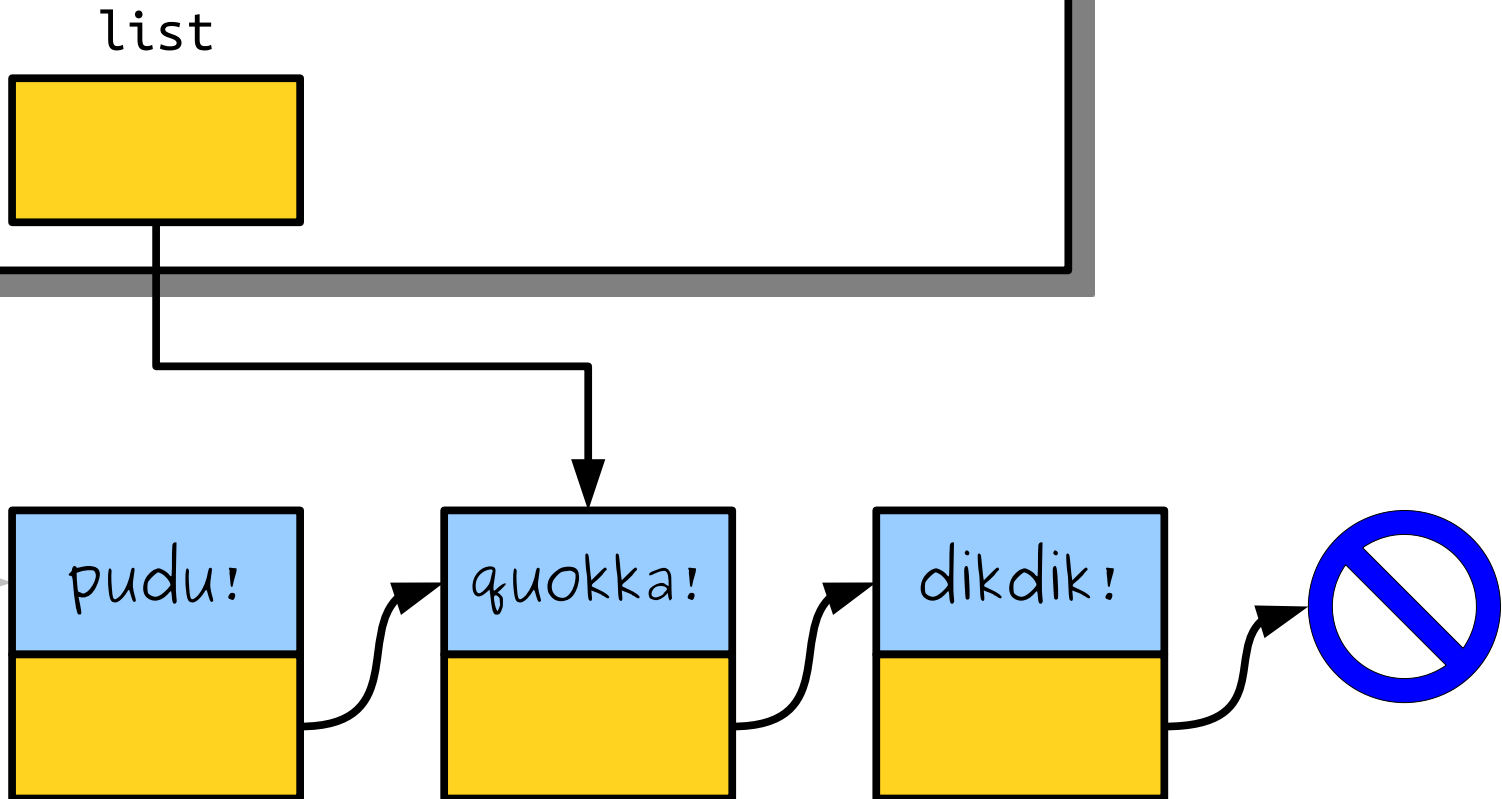

```
int main() {
```

```
void printlist(Cell* list) {
```

```
while (list != nullptr) {
```

```
    cout << list->value << endl;
```

```
    list = list->next;
```

```
}
```

```
}
```

list

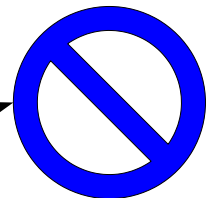
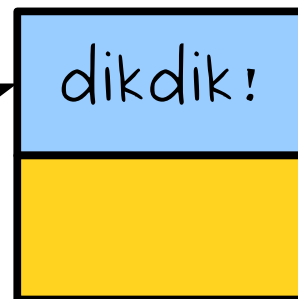
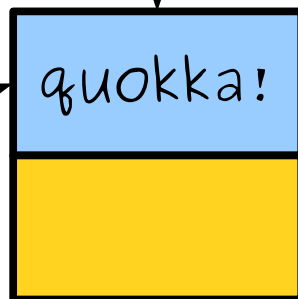
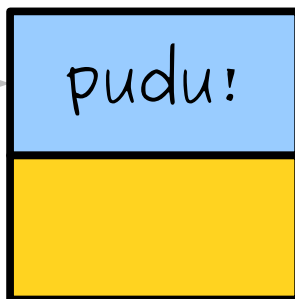

```
int main() {
```

```
void printList(Cell* list) {
```

```
while (list != nullptr) {
```

```
    cout << list->value << endl;
```

```
    list = list->next;
```

```
}
```

```
}
```

list

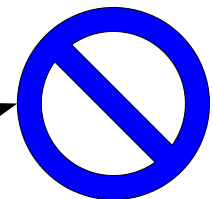
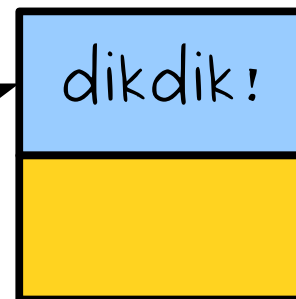
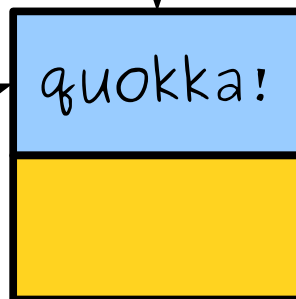
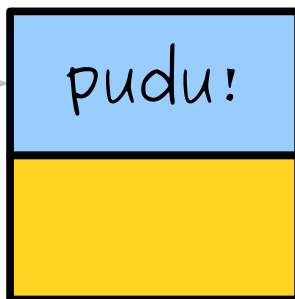

```
int main() {  
    void printList(Cell* list) {  
        while (list != nullptr) {  
            cout << list->value << endl;  
            list = list->next;  
        }  
    }  
}
```

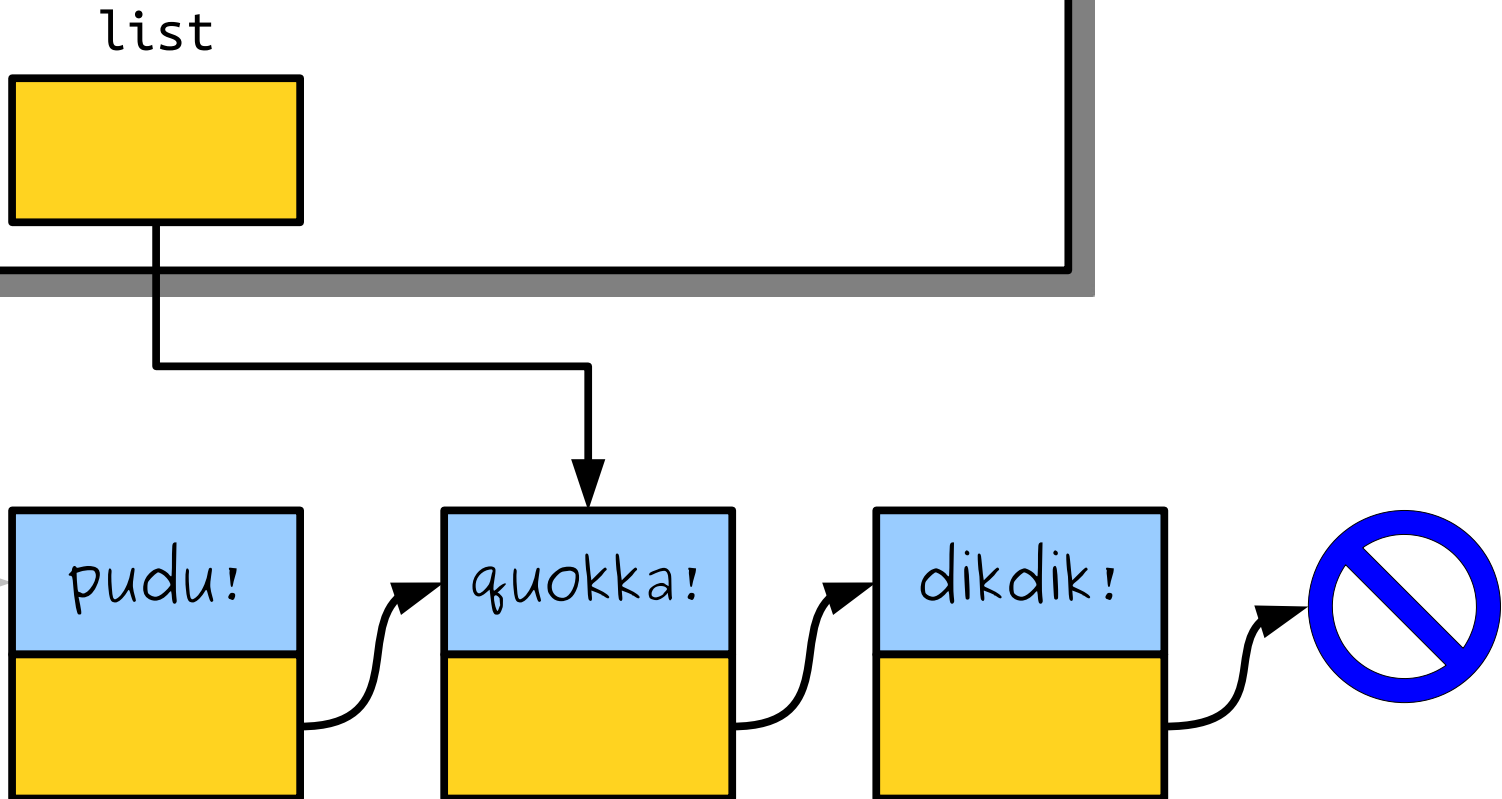

```
int main() {  
    void printList(Cell* list) {  
        while (list != nullptr) {  
            cout << list->value << endl;  
            list = list->next;  
        }  
    }  
}
```

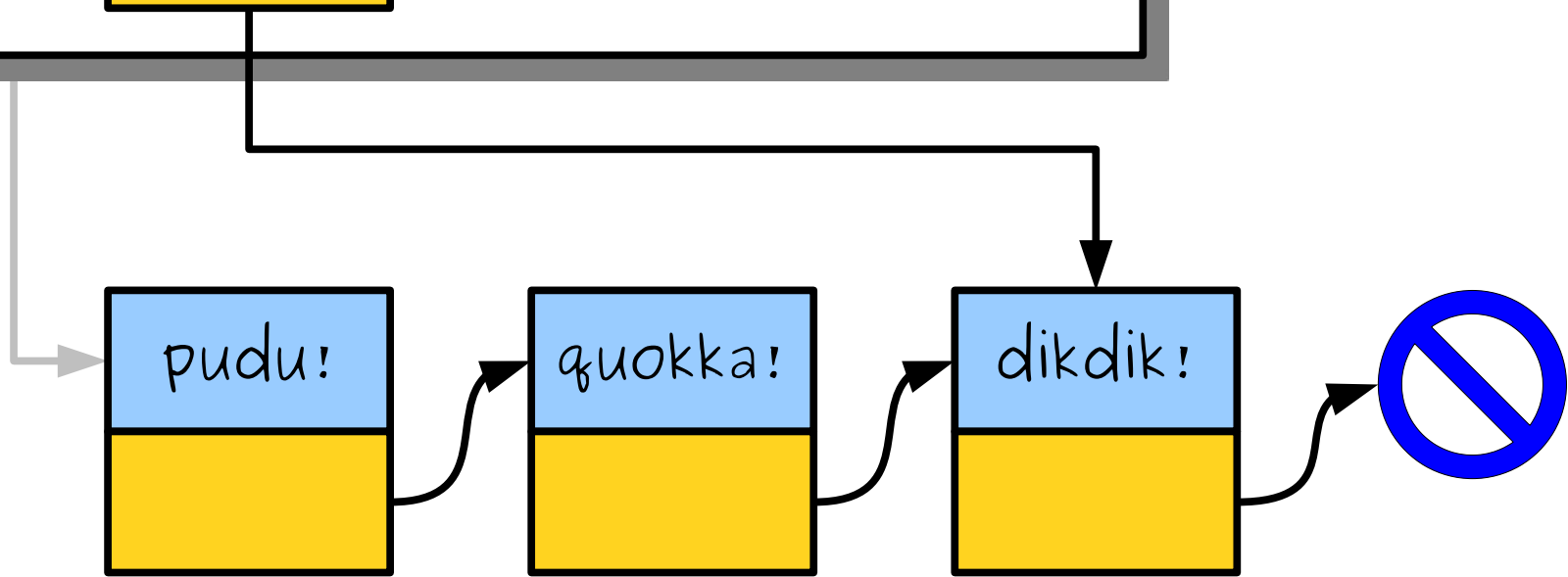

```
int main() {
```

```
void printlist(Cell* list) {
```

```
while (list != nullptr) {
```

```
    cout << list->value << endl;
```

```
    list = list->next;
```

```
}
```

```
}
```

list

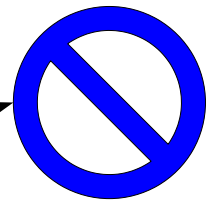
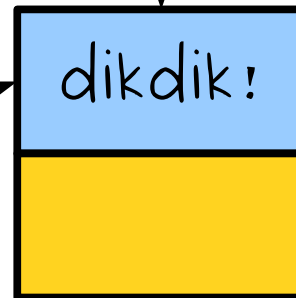
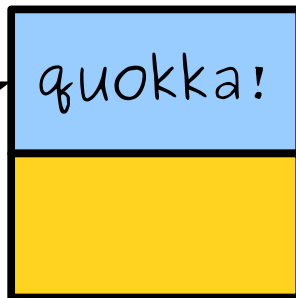
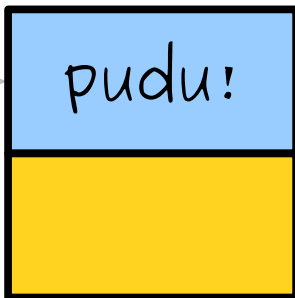

```
int main() {
```

```
void printList(Cell* list) {  
  while (list != nullptr) {  
    cout << list->value << endl;  
    list = list->next;  
  }  
}
```

list

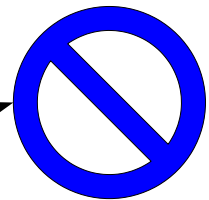
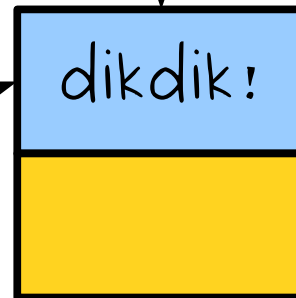
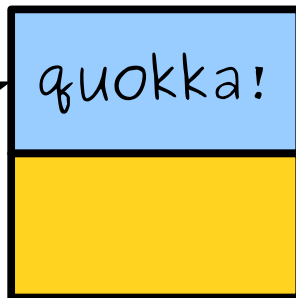
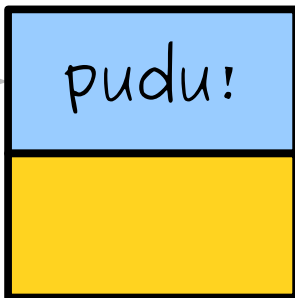

```
int main() {
```

```
void printList(Cell* list) {  
    while (list != nullptr) {  
        cout << list->value << endl;  
        list = list->next;  
    }  
}
```

list

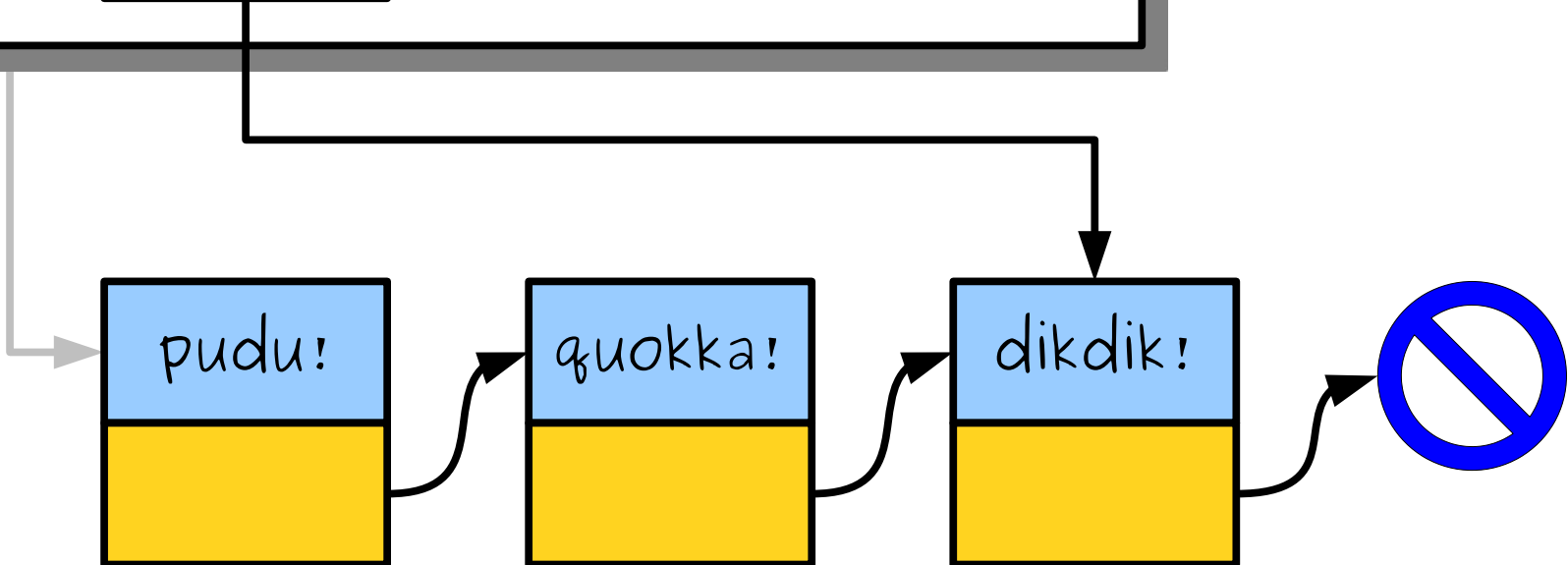

```
int main() {
```

```
void printList(Cell* list) {  
    while (list != nullptr) {  
        cout << list->value << endl;  
        list = list->next;  
    }  
}
```

list

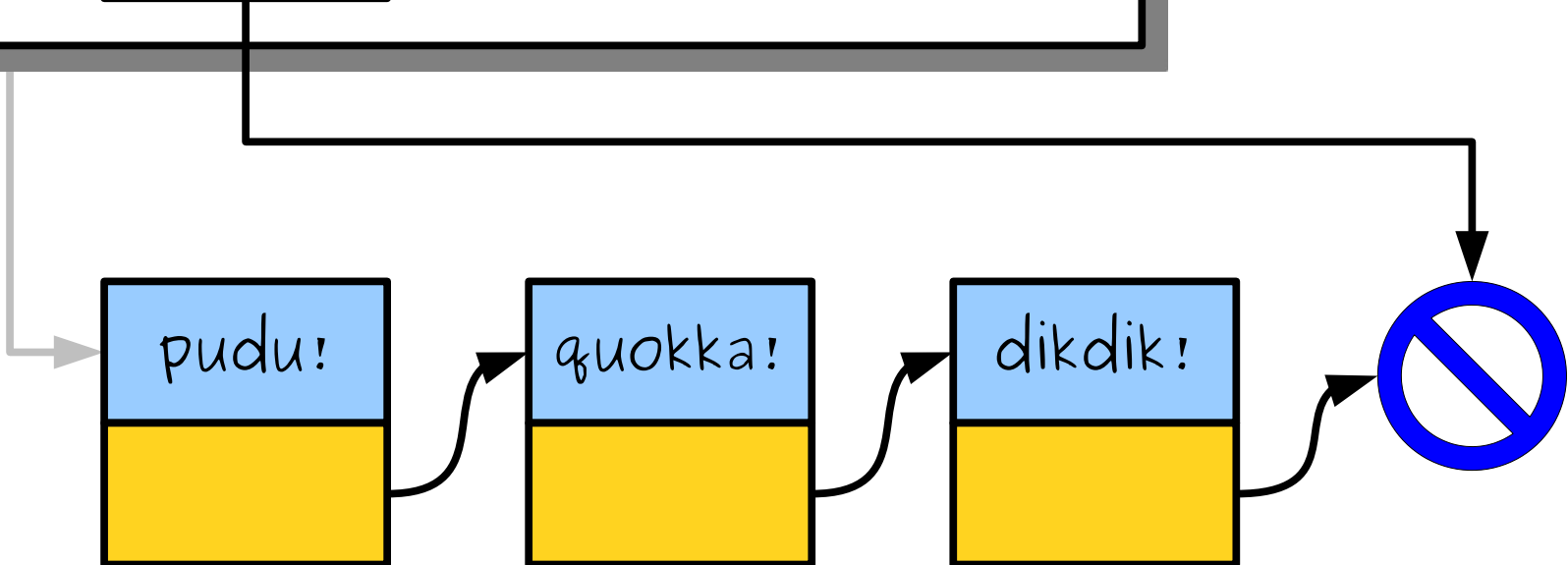

```
int main() {
```

```
void printlist(Cell* list) {
```

```
while (list != nullptr) {
```

```
    cout << list->value << endl;
```

```
    list = list->next;
```

```
}
```

```
}
```

list

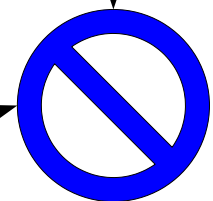
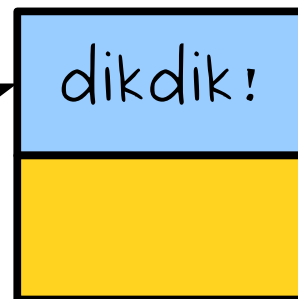
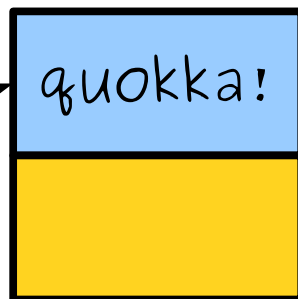
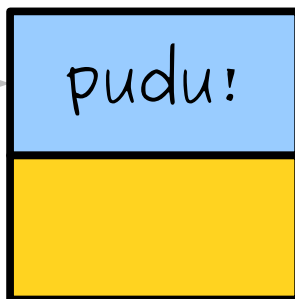

```
int main() {  
    Cell* list = /* ... a list ... */;  
    printList(list);  
  
    /* ... other listy things. ... */  
}
```

list

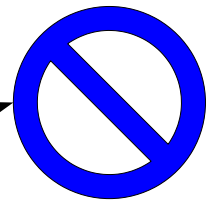
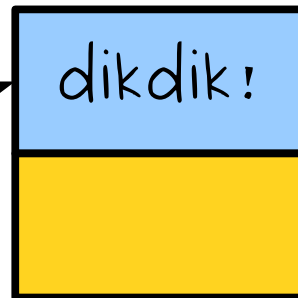
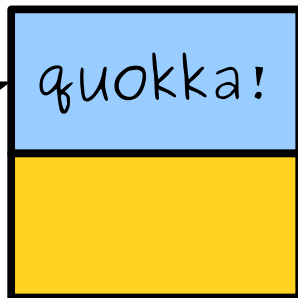
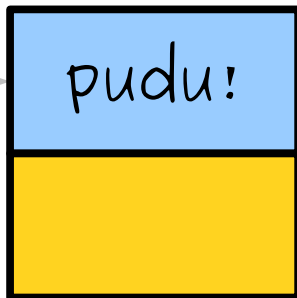

```
int main() {  
  Cell* list = /* ... a list ... */;  
  printList(list);  
  
  /* ... other listy things. ... */  
}
```

list

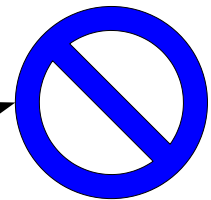
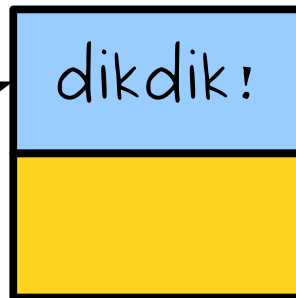
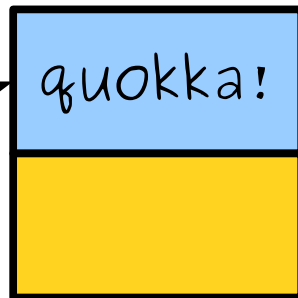
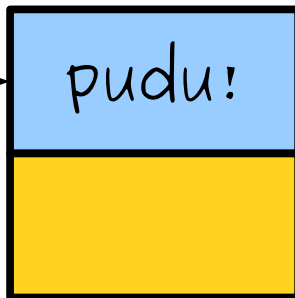

Making a Minor Change

```
int main() {  
    Cell* list = /* ... a list ... */;  
    printList(list);  
  
    /* ... other listy things. ... */  
}
```

```
int main() {  
    Cell* list = /* ... a list ... */;  
    printList(list);  
  
    /* ... other listy things. ... */  
}
```

```
int main() {  
    Cell* list = /* ... a list ... */;  
    printList(list);  
  
    /* ... other listy things. ... */  
}
```

list

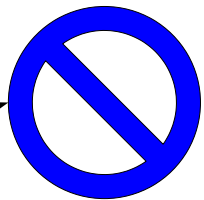
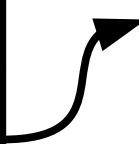
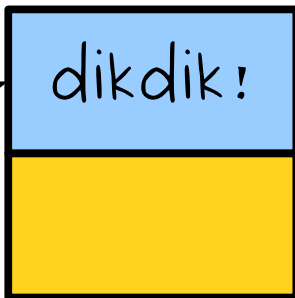
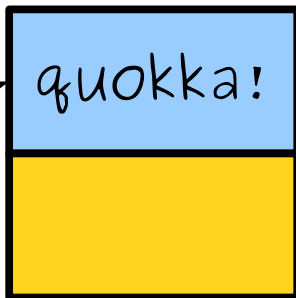
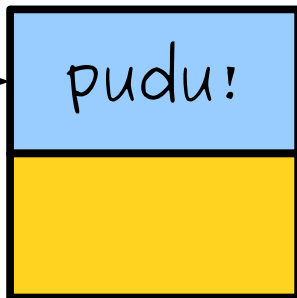

```
int main() {  
  Cell* list = /* ... a list ... */;  
  printList(list);  
  
  /* ... other listy things. ... */  
}
```

list

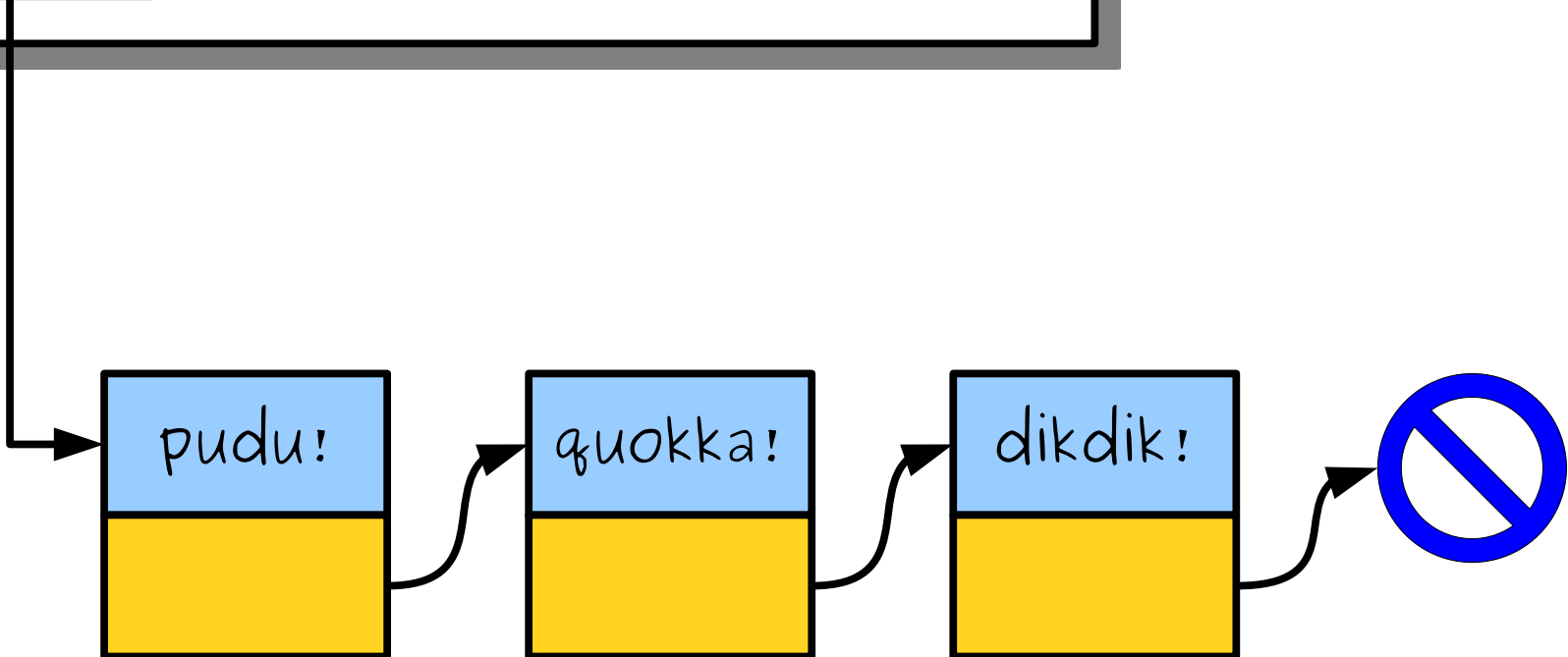

```
int main() {  
    Cell* list = /* ... a list ... */;  
    printList(list);  
  
    /* ... other listy things. ... */  
}
```

list

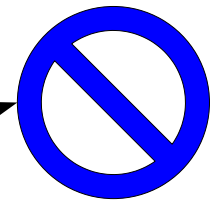
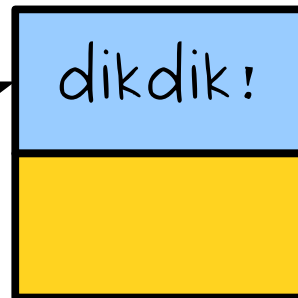
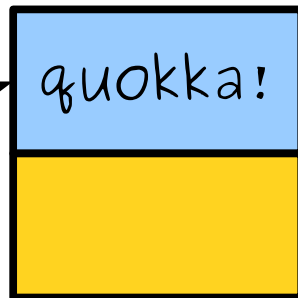
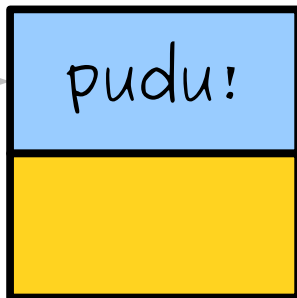

```
int main() {
```

```
void printList(Cell* list) {  
    while (list != nullptr) {  
        list = list->next;  
        cout << list->value << endl;  
    }  
}
```

list

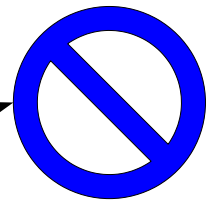
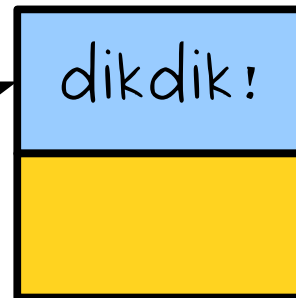
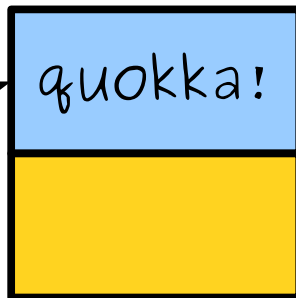
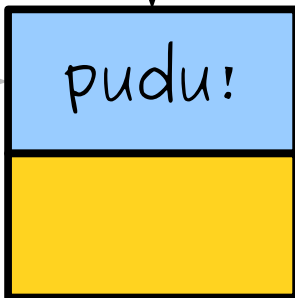

```
int main() {  
    void printlist(Cell* list) {  
        while (list != nullptr) {  
            list = list->next;  
            cout << list->value << endl;  
        }  
    }  
}
```

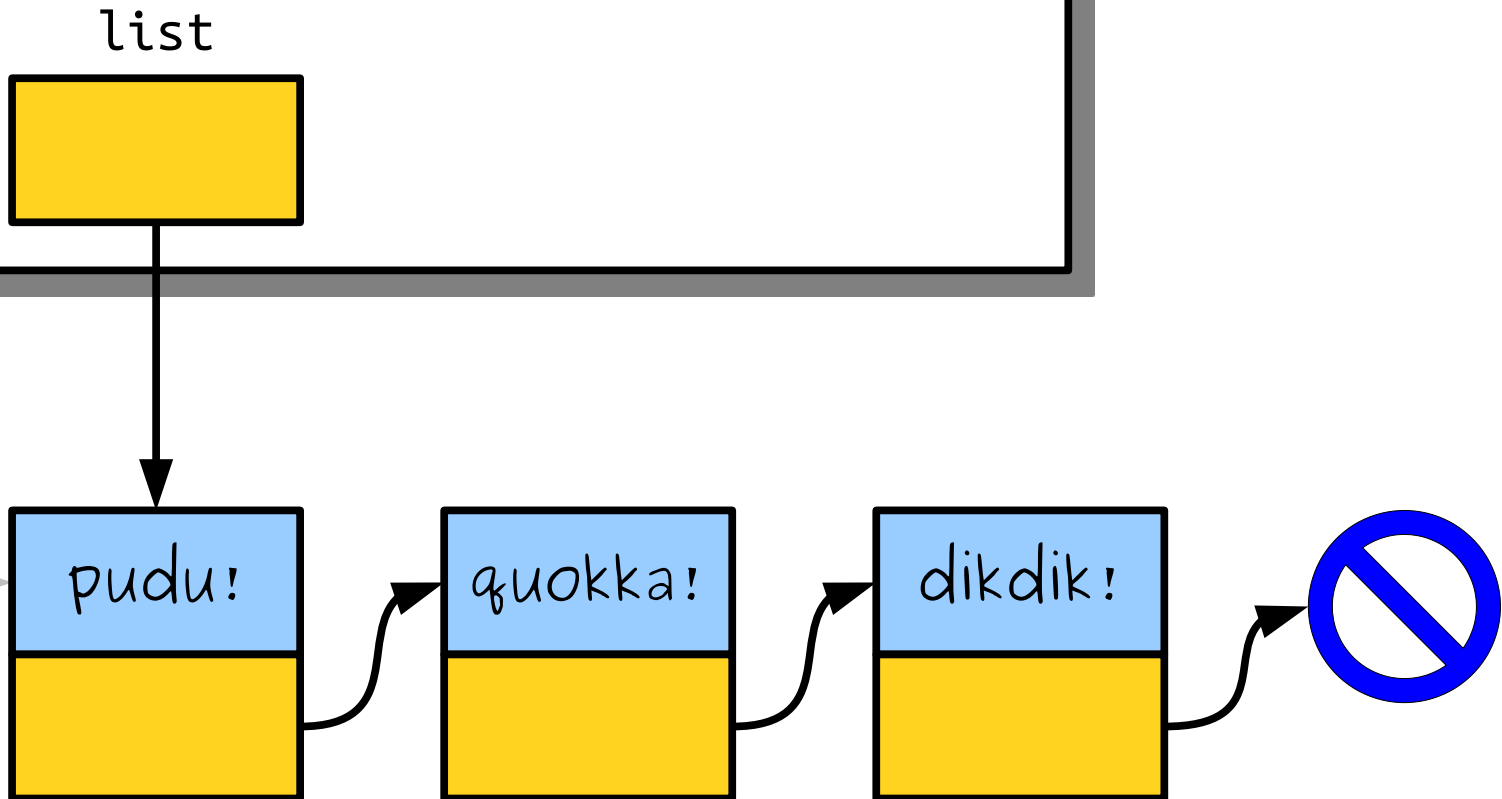

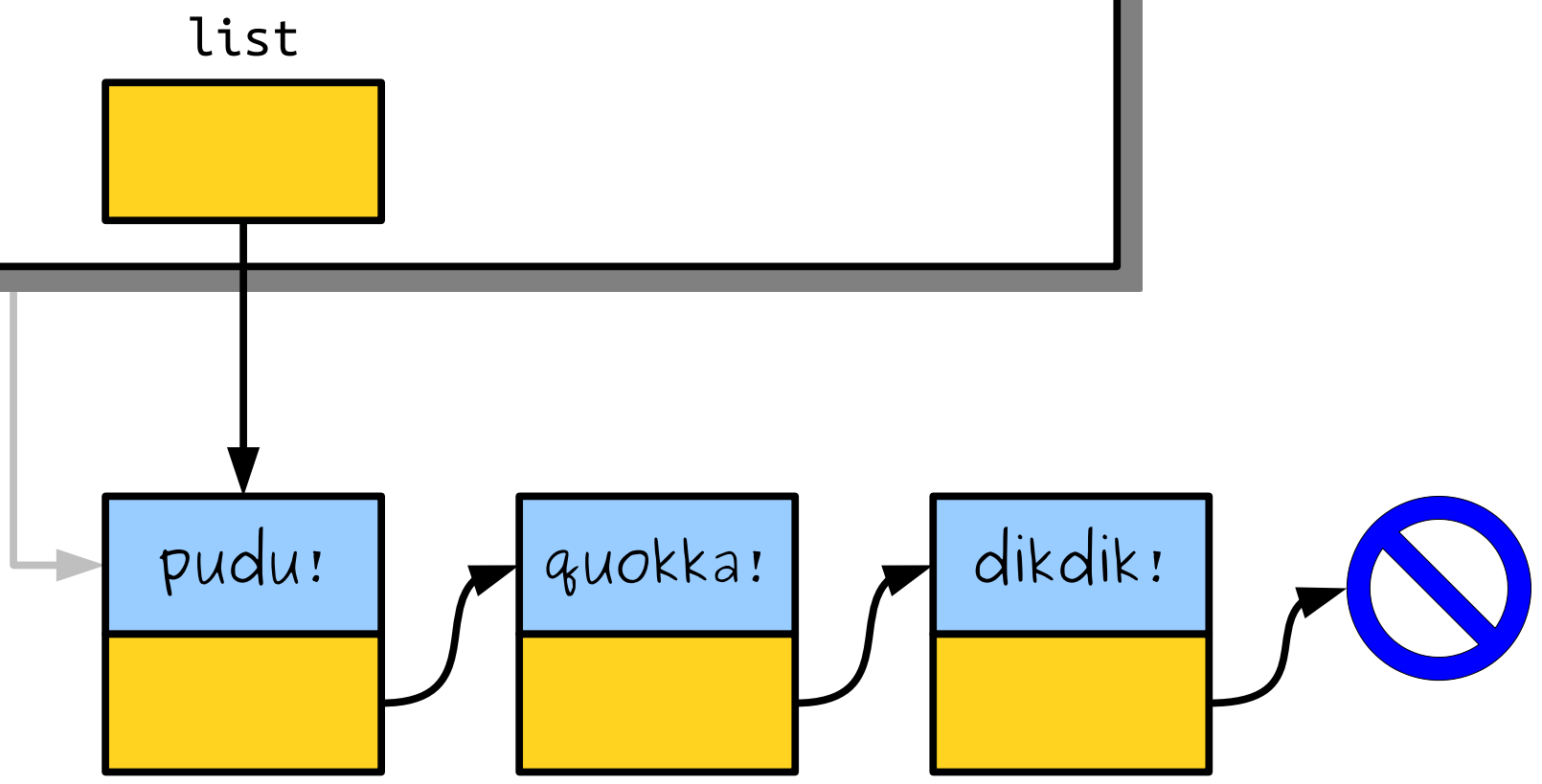

```
int main() {  
    void printList(Cell* list) {  
        while (list != nullptr) {  
            list = list->next;  
            cout << list->value << endl;  
        }  
    }  
}
```

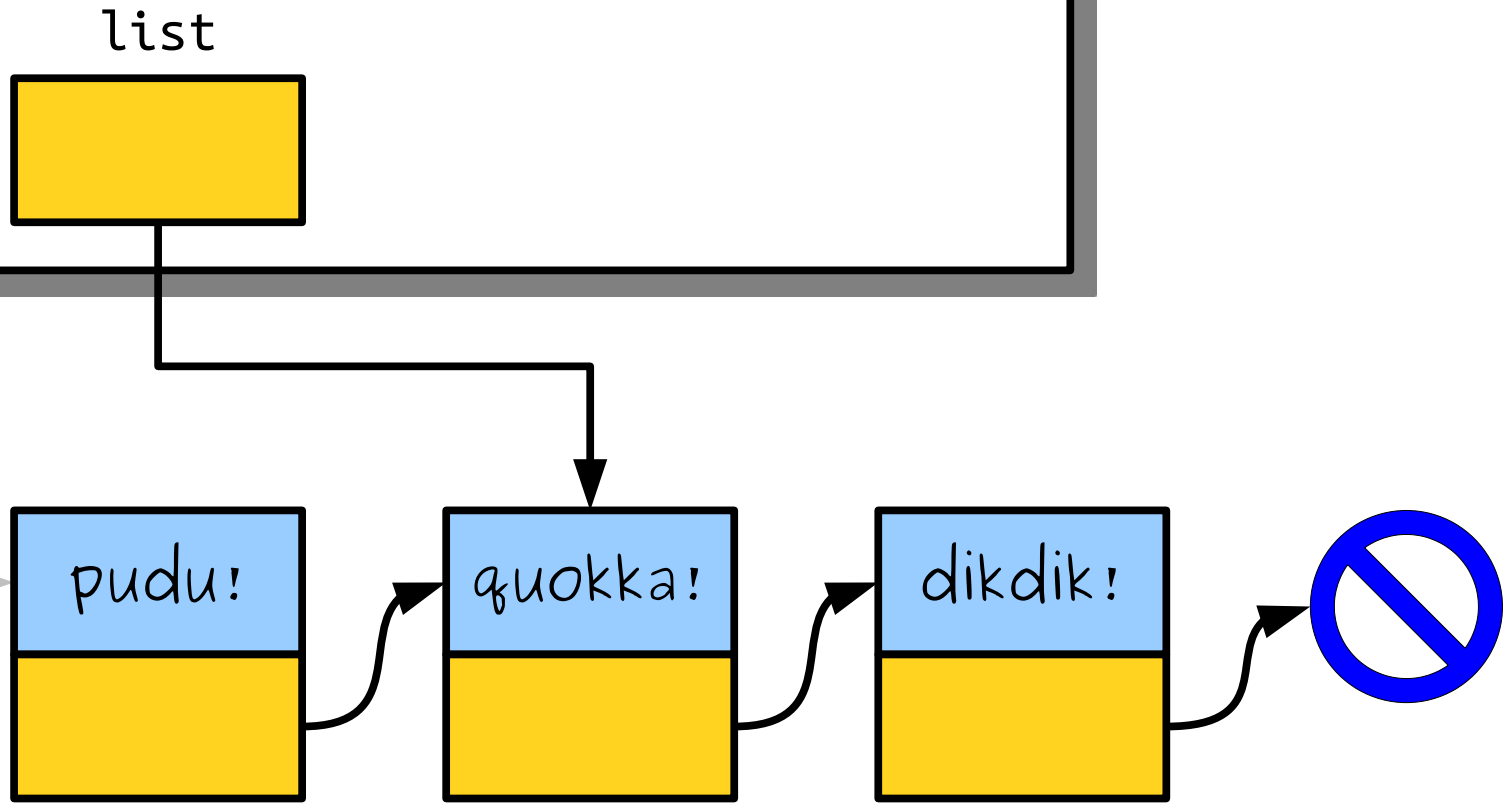

```
int main() {  
    void printList(Cell* list) {  
        while (list != nullptr) {  
            list = list->next;  
            cout << list->value << endl;  
        }  
    }  
}
```

list = list->next;



```
int main() {
```

```
void printList(Cell* list) {  
    while (list != nullptr) {  
        list = list->next;  
        cout << list->value << endl;  
    }  
}
```

cout << list->value << endl;

list

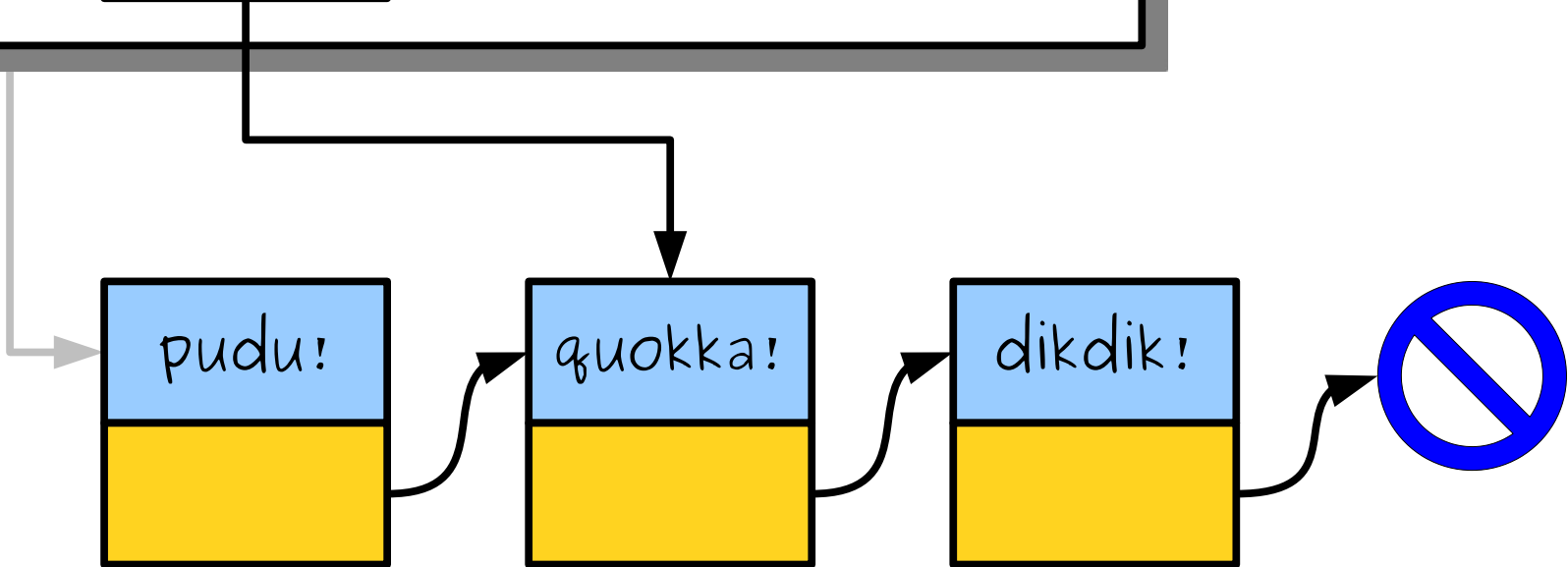

```
int main() {
```

```
void printlist(Cell* list) {
```

```
while (list != nullptr) {
```

```
list = list->next;
```

```
cout << list->value << endl;
```

```
}
```

```
}
```

list

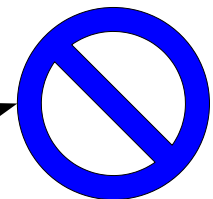
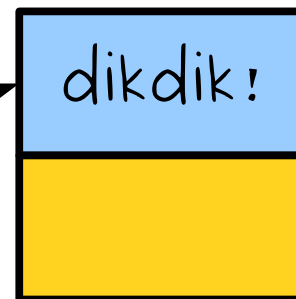
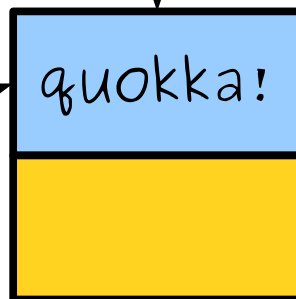
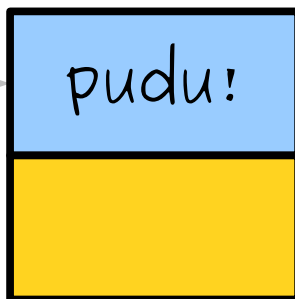

```
int main() {  
    void printList(Cell* list) {  
        while (list != nullptr) {  
            list = list->next;  
            cout << list->value << endl;  
        }  
    }  
}
```

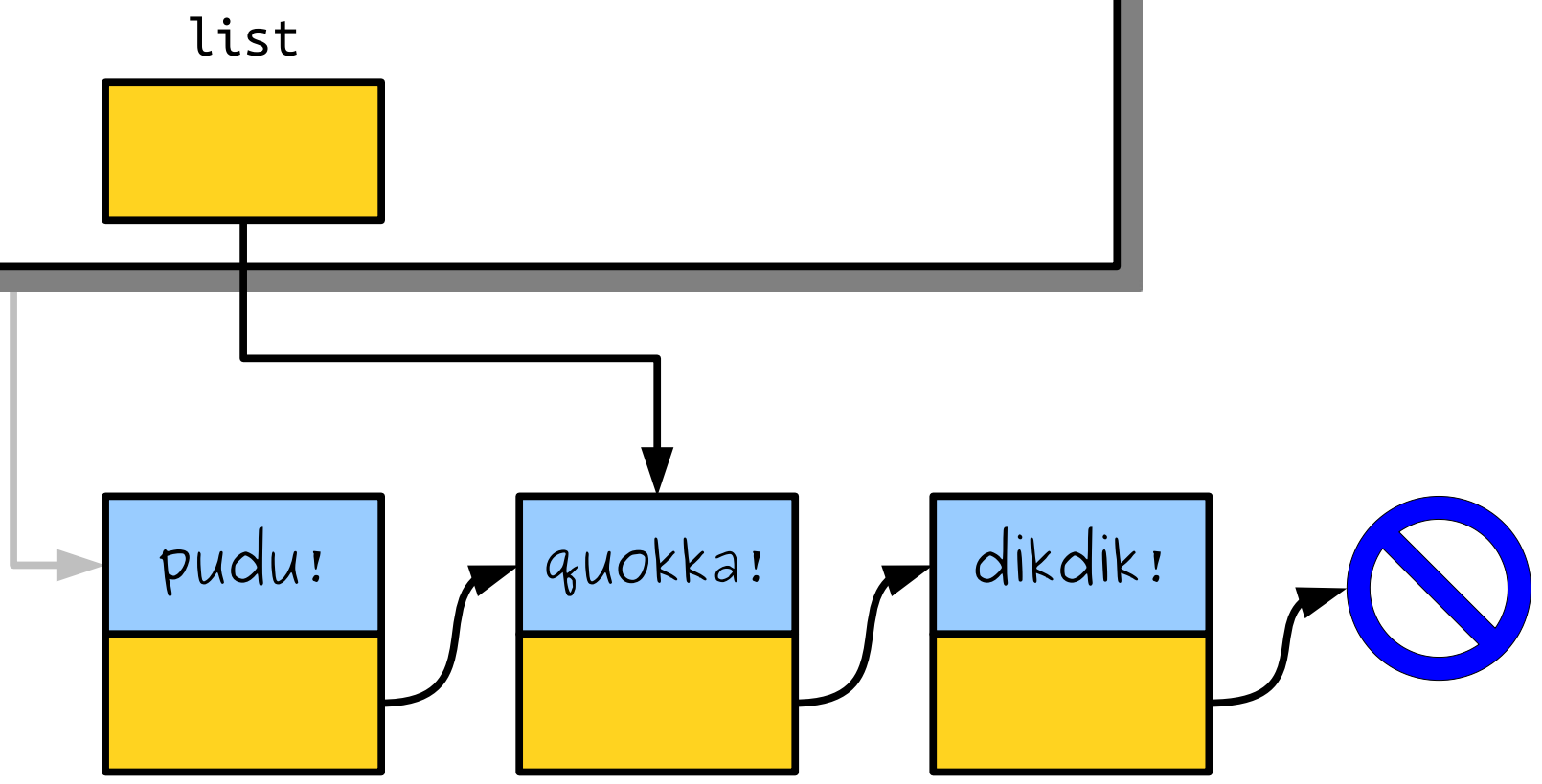

```
int main() {  
    void printList(Cell* list) {  
        while (list != nullptr) {  
            list = list->next;  
            cout << list->value << endl;  
        }  
    }  
}
```

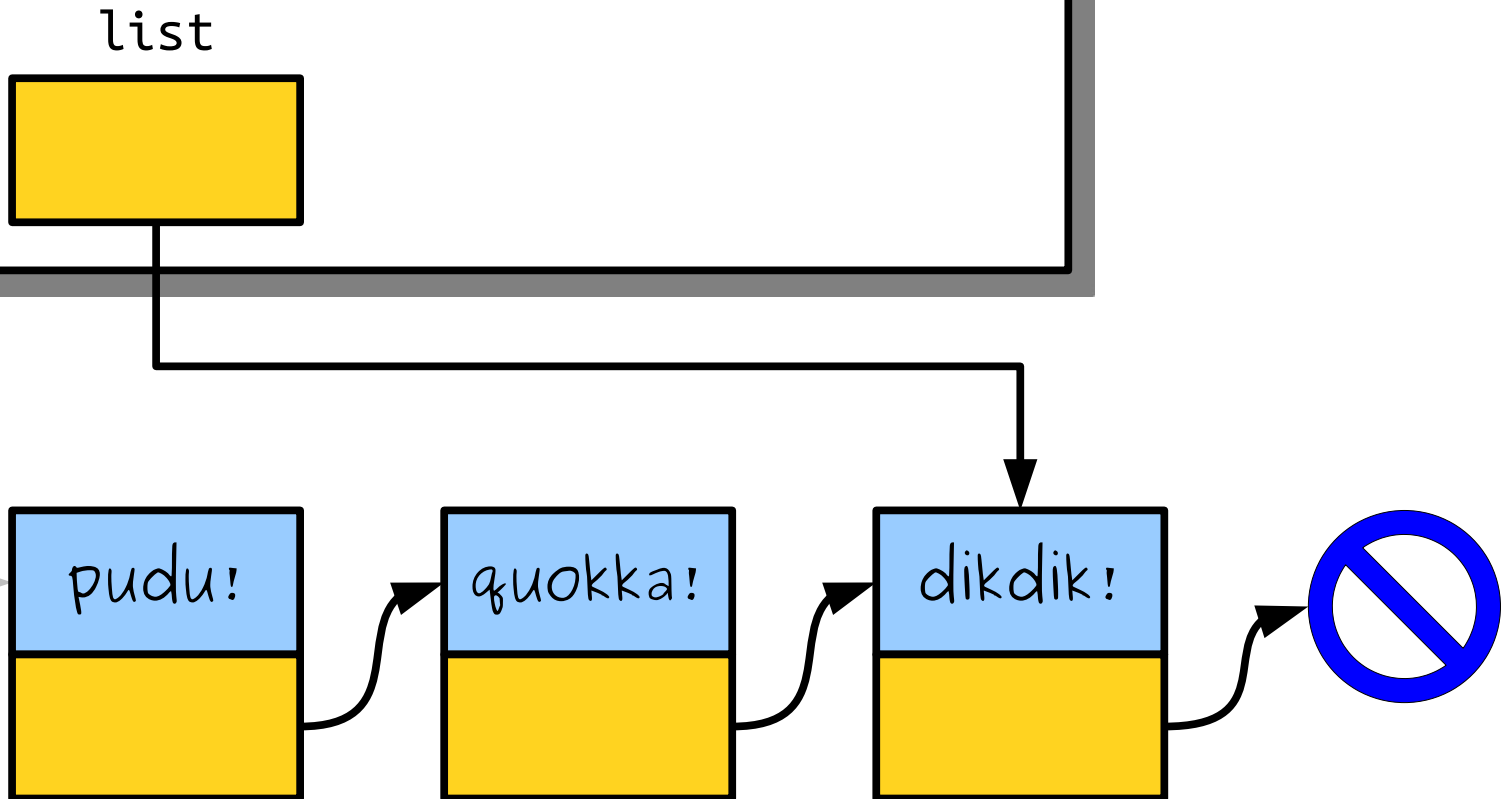

```
int main() {
```

```
void printList(Cell* list) {  
    while (list != nullptr) {  
        list = list->next;  
        cout << list->value << endl;  
    }  
}
```

cout << list->value << endl;

list

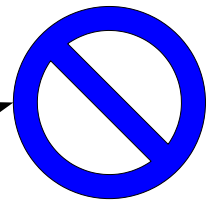
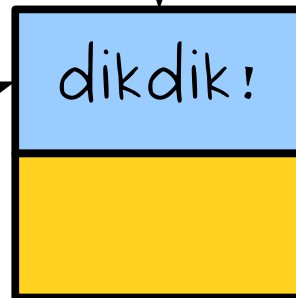
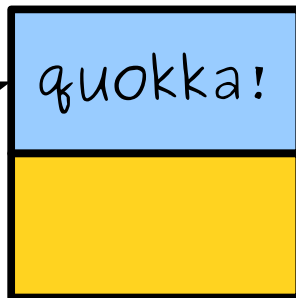
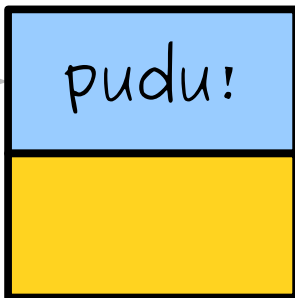

```
int main() {  
    void printlist(Cell* list) {  
        while (list != nullptr) {  
            list = list->next;  
            cout << list->value << endl;  
        }  
    }  
}
```

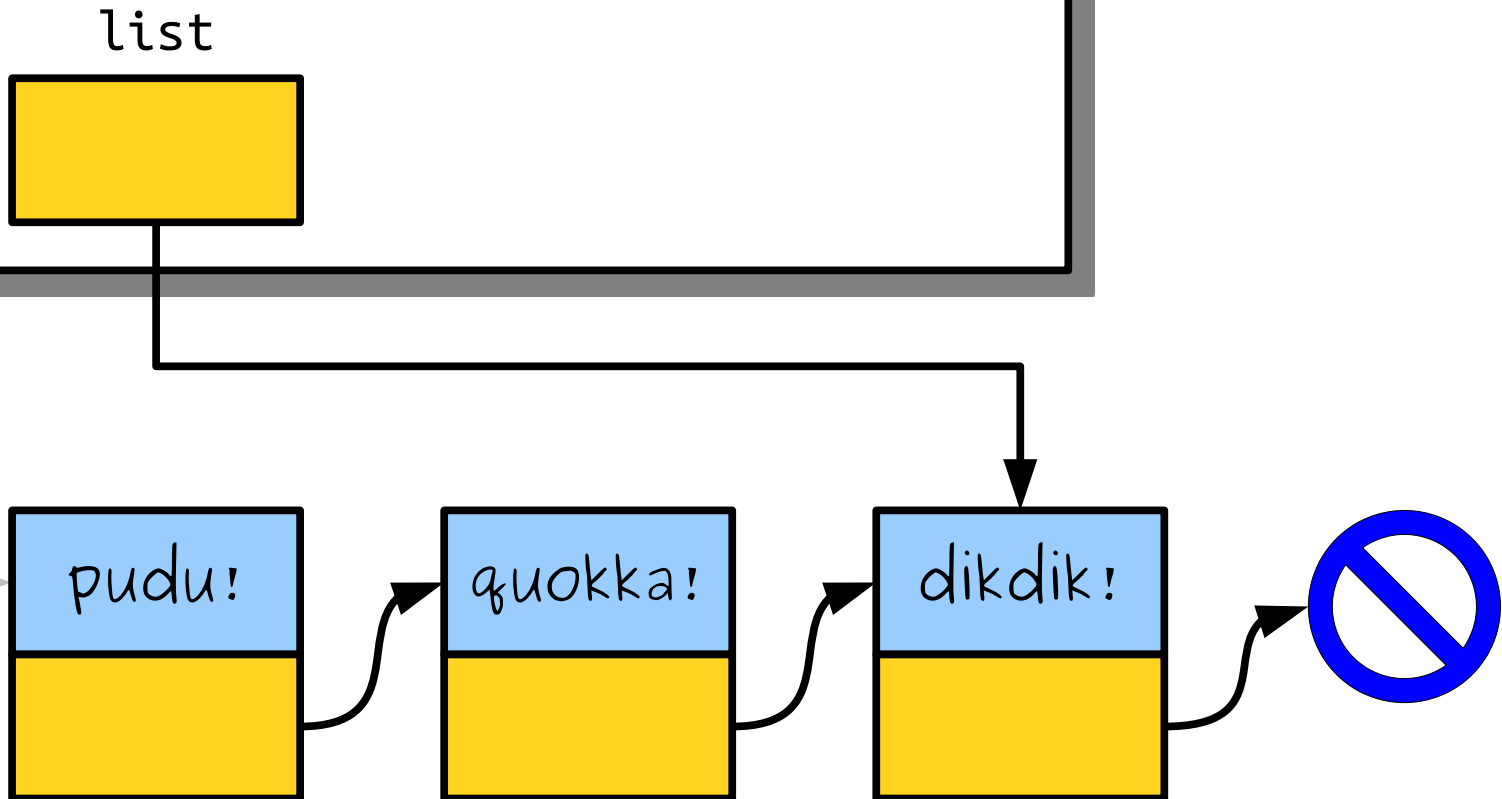

```
int main() {  
    void printList(Cell* list) {  
        while (list != nullptr) {  
            list = list->next;  
            cout << list->value << endl;  
        }  
    }  
}
```

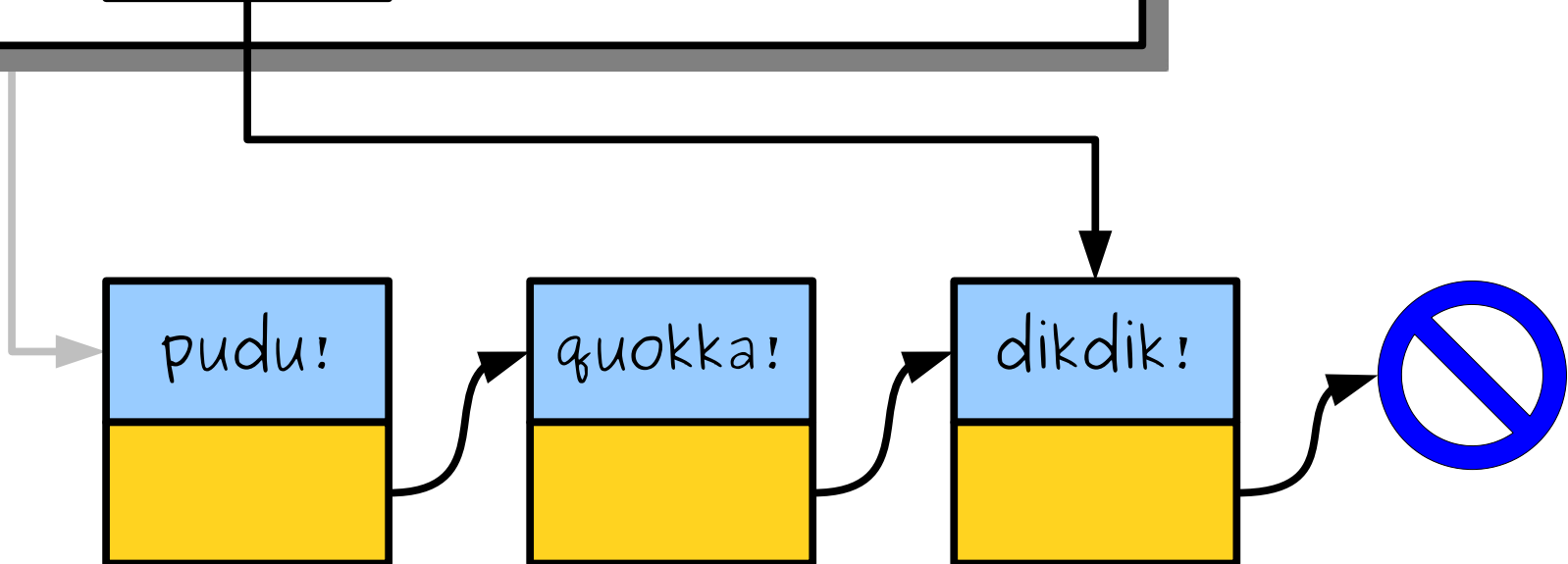

```
int main() {  
    void printList(Cell* list) {  
        while (list != nullptr) {  
            list = list->next;  
            cout << list->value << endl;  
        }  
    }  
}
```

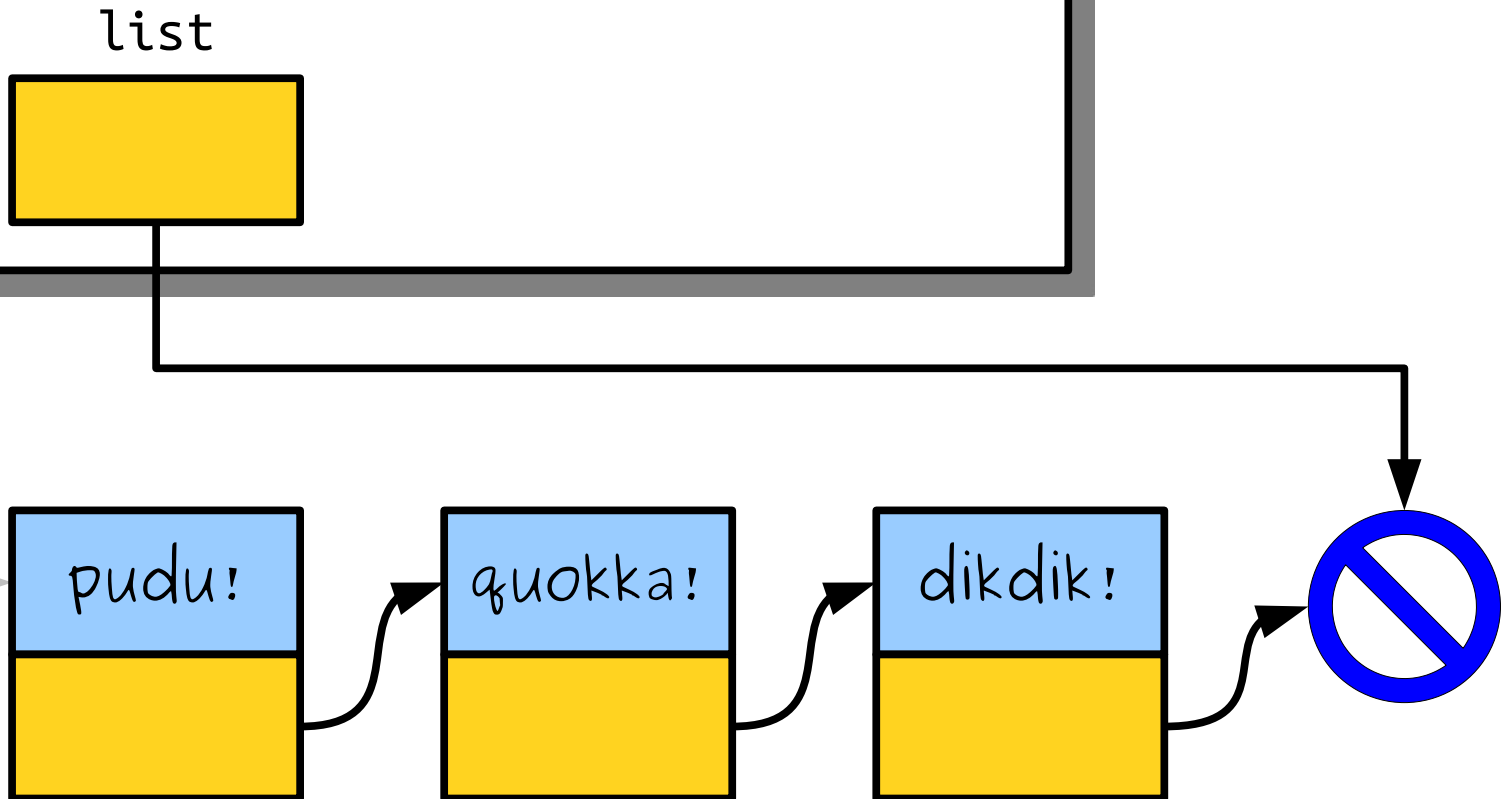

```
int main() {
```

```
void printList(Cell* list) {  
    while (list != nullptr) {  
        list = list->next;  
        cout << list->value << endl;  
    }  
}
```

list

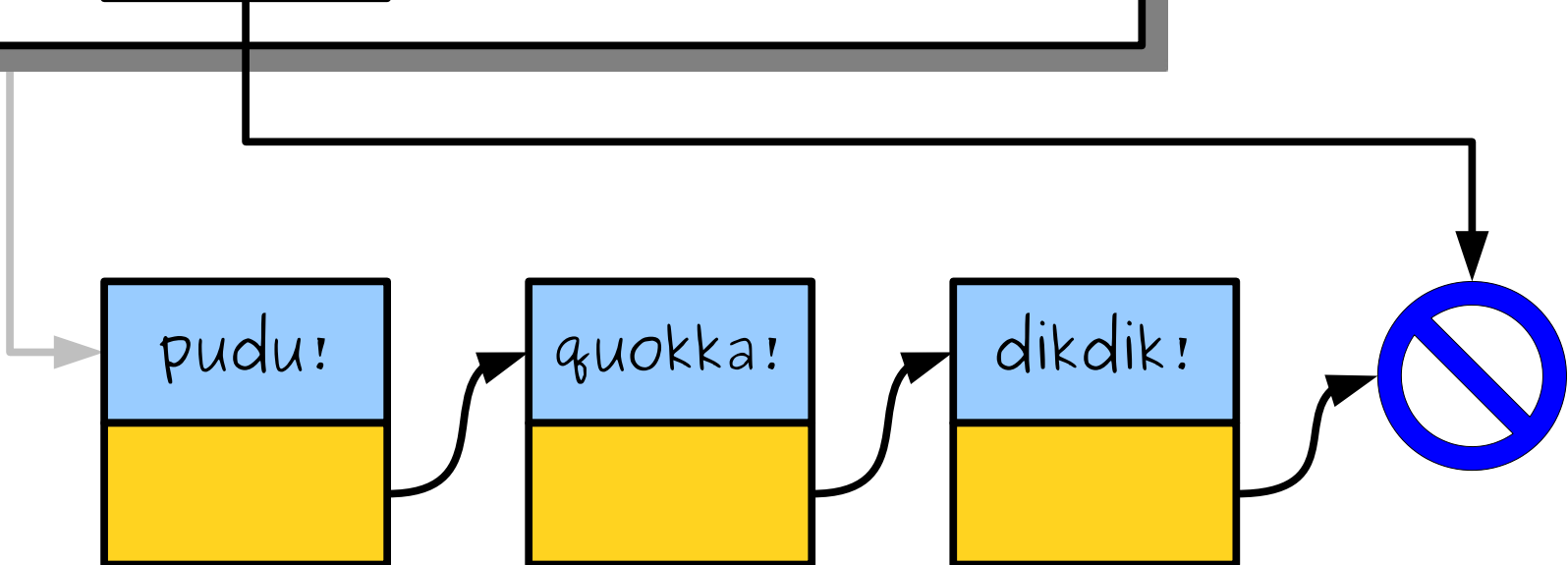

```
int main() {
```

```
void printList(Cell* list) {  
    while (list != nullptr) {  
        list = list->next;  
        cout << list->value << endl;  
    }  
}
```

list

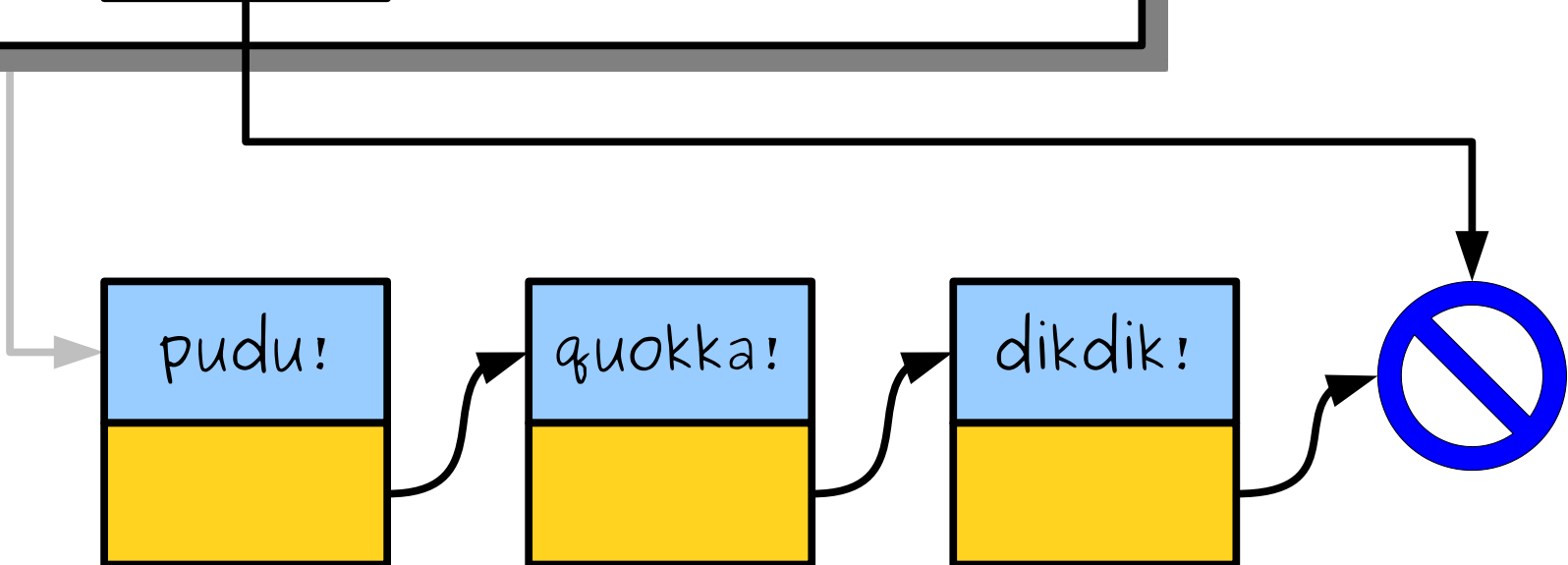

```
int main() {  
    void printList(Cell* list) {  
        while (list != nullptr) {  
            list = list->next;  
            cout << list->value << endl;  
        }  
    }  
}
```

list

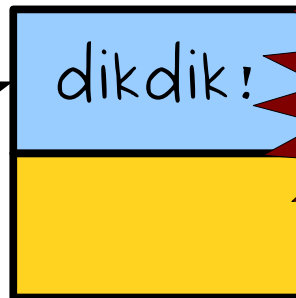
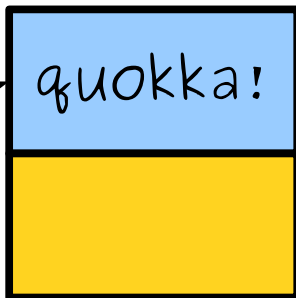
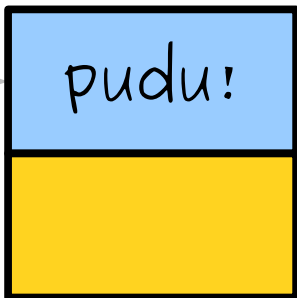

Time-Out for Announcements!

Looking Ahead: Partners

- Assignment 6 (the one out this week) must be completed individually.
- Assignments 7 and 8 may be done either individually or with a partner.
- Your partner must be in the same section as you.
- If you know someone you want to work with but are not in their section, ping Jonathan by Wednesday so we can make the swap.

Tone Matrix Contest

- We're holding a Tone Matrix contest, analogous to the Recursive Drawing contest we ran earlier in the quarter.
- Interested in entering?
 - Record a video using your Tone Matrix program. Be creative!
 - Post a link to the video on the EdStem thread set up for the contest.
- Deadline to submit is next ***Monday, March 3*** at ***1:00PM***.
- We'll award a small number of prizes to popular entries. This is 100% optional and has no bearing on your course grade.



```
lecture = lecture->next;
```

Building a Linked List

(without hardcoding it)

A Linked List is Either...

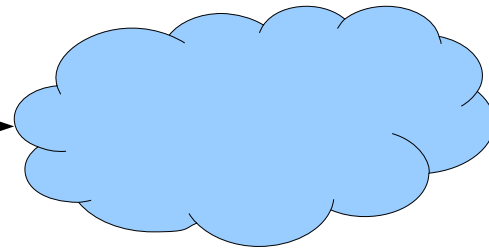
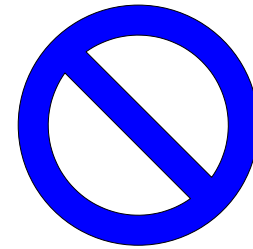
...an empty list,
represented by
nullptr, or...



a single linked list
cell that points...

... at another linked
list.

Cleaning Up a Linked List

Endearing C++ Quirks

- If you allocate memory using the `new[]` operator (e.g. `new int[137]`), you have to free it using the `delete[]` operator.

```
delete[] ptr;
```

- If you allocate memory using the `new` operator (e.g. `new Cell`), you have to free it using the `delete` operator.

```
delete ptr;
```

- ***Make sure to use the proper deletion operation.*** Mixing these up is like walking off the end of an array or using an uninitialized pointer; it *might* work, or it might instantly crash your program, etc.

Cleaning Up Memory

- To free a linked list, we can't just do this:
`delete list;`
- Why not?

Cleaning Up Memory

- To free a linked list, we can't just do this:
`delete list;`

- Why not?

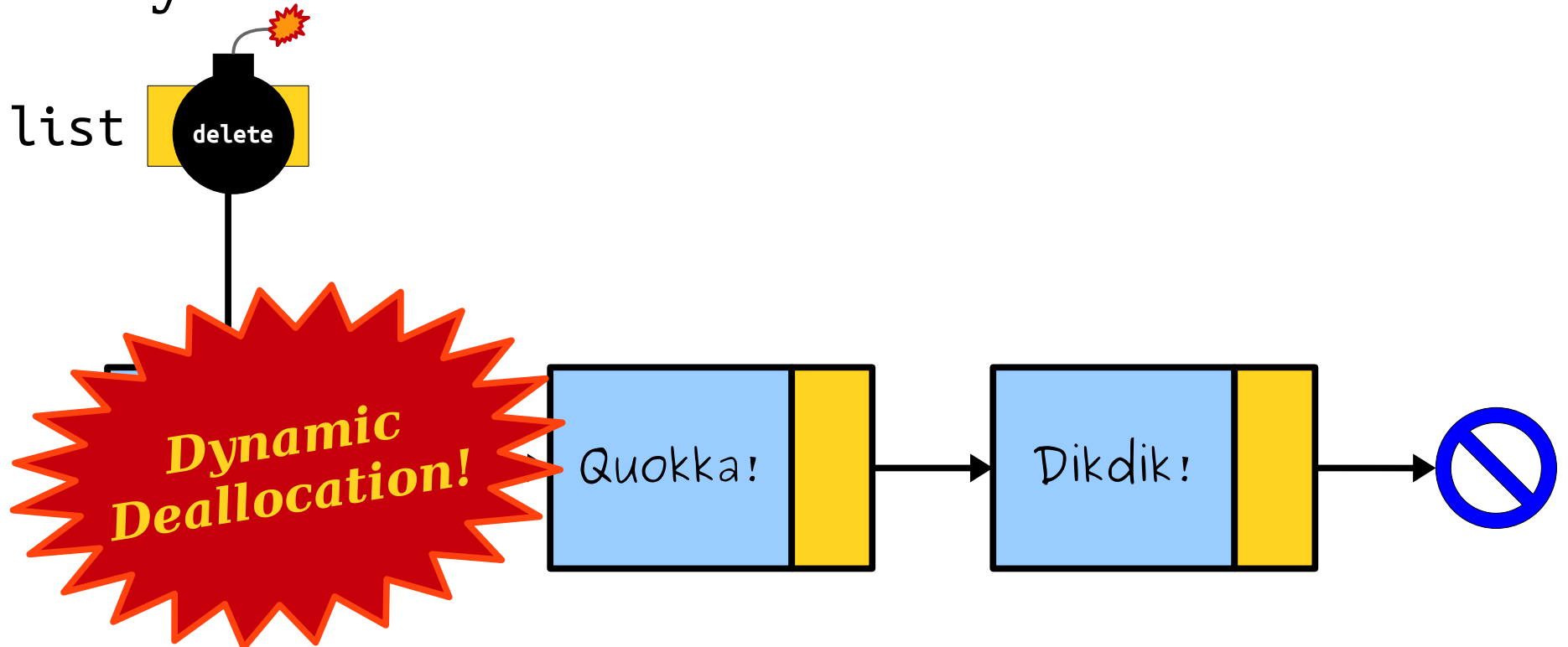

Cleaning Up Memory

- To free a linked list, we can't just do this:

delete list;

- Why not?

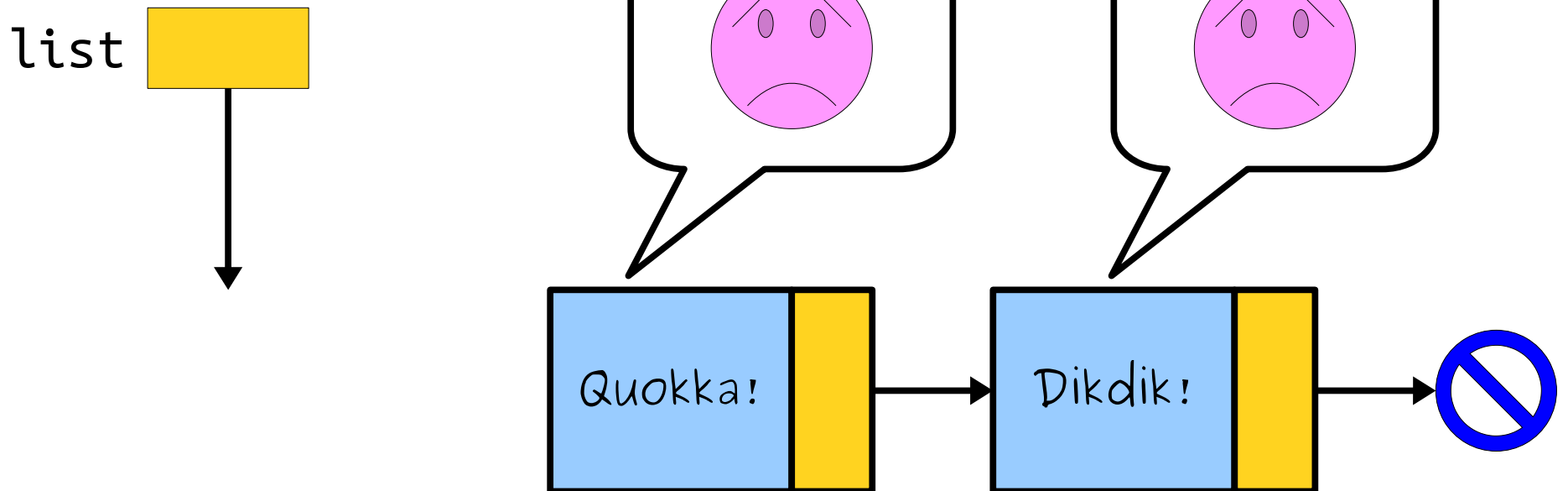

First, the Wrong Way

```
void deleteList(Cell* list) {  
    // WRONG WRONG WRONG WRONG  
    // WRONG WRONG WRONG WRONG  
  
    while (list != nullptr) {  
        delete list;  
        list = list->next;  
    }  
}
```

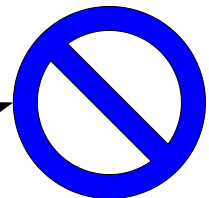
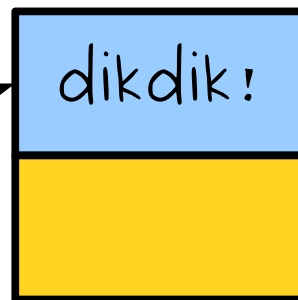
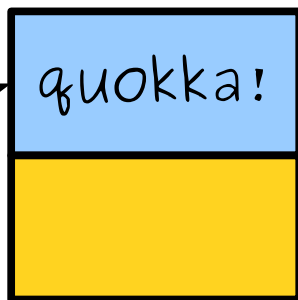
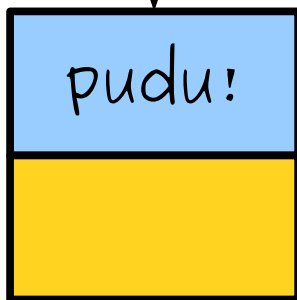

```
void deleteList(Cell* list) {  
    // WRONG WRONG WRONG WRONG  
    // WRONG WRONG WRONG WRONG  
  
    while (list != nullptr) {  
        delete list;  
        list = list->next;  
    }  
}
```

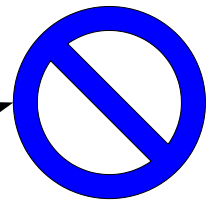
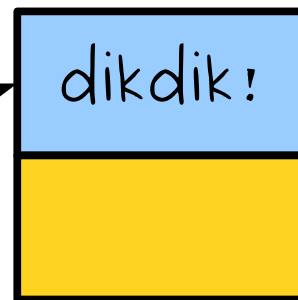
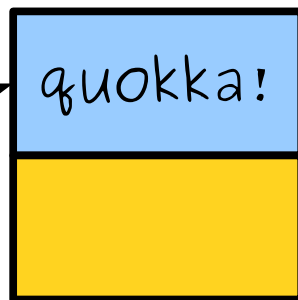
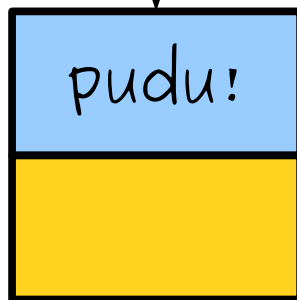

```
void deleteList(Cell* list) {  
    // WRONG WRONG WRONG WRONG  
    // WRONG WRONG WRONG WRONG  
  
    while (list != nullptr) {  
        delete list;  
        list = list->next;  
    }  
}
```

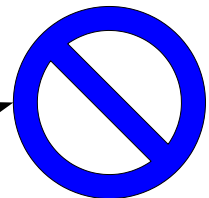
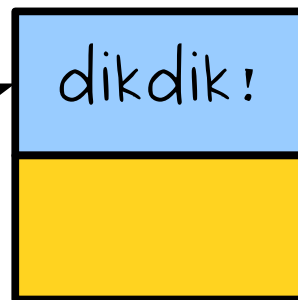
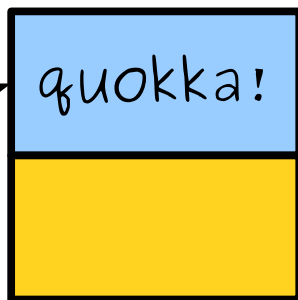
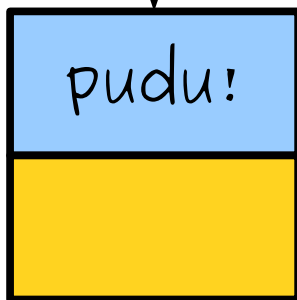

```
void deleteList(Cell* list) {  
    // WRONG WRONG WRONG WRONG  
    // WRONG WRONG WRONG WRONG  
  
    while (list != nullptr) {  
        delete list;  
        list = list->next;  
    }  
}
```



**Dynamic
Deallocation!**

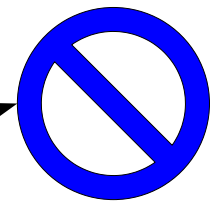
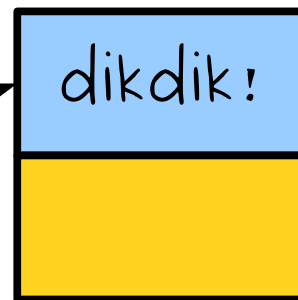
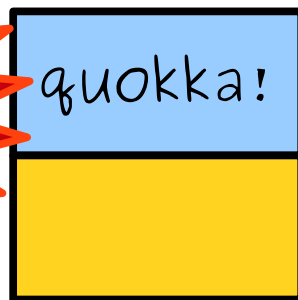

```
void deleteList(Cell* list) {  
    // WRONG WRONG WRONG WRONG  
    // WRONG WRONG WRONG WRONG  
  
    while (list != nullptr) {  
        delete list;  
        list = list->next;  
    }  
}
```

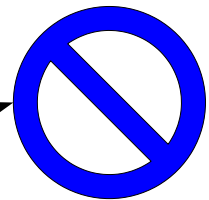
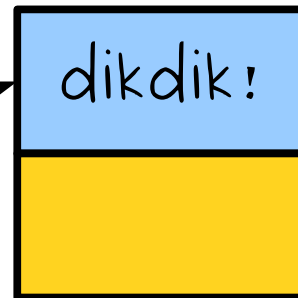
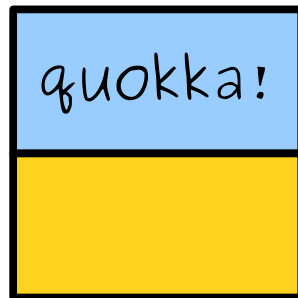

```
void deleteList(Cell* list) {  
    // WRONG WRONG WRONG WRONG  
    // WRONG WRONG WRONG WRONG  
  
    while (list != nullptr) {  
        delete list;  
        list = list->next;  
    }  
}
```

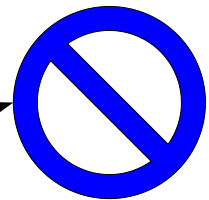
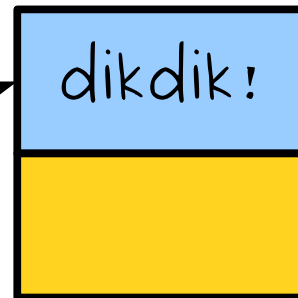
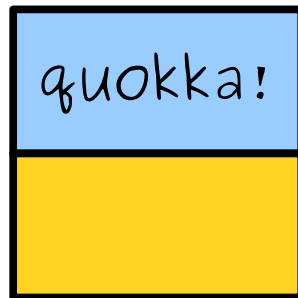

```
void deleteList(Cell* list) {  
    // WRONG WRONG WRONG WRONG  
    // WRONG WRONG WRONG WRONG  
    while (list != NULL) {  
        delete list;  
        list = list->next;  
    }  
}
```

**Undefined
behavior!**

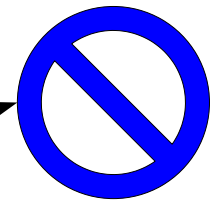
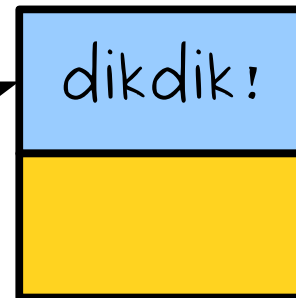

In the Land of C++, we
do not speak to the dead.

What should we do instead?

```
void deleteList(Cell* list) {  
    while (list != nullptr) {  
        delete list;  
        list = list->next;  
    }  
}
```

list

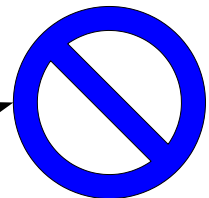
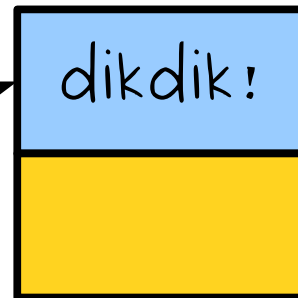
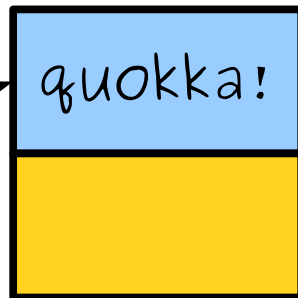
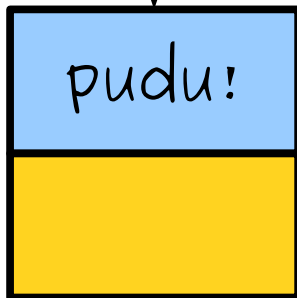

```
void deleteList(Cell* list) {  
    while (list != nullptr) {  
        Cell* next = list->next;  
        delete list;  
        list = list->next;  
    }  
}
```

list

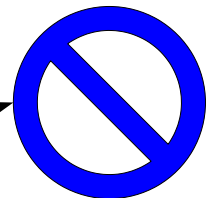
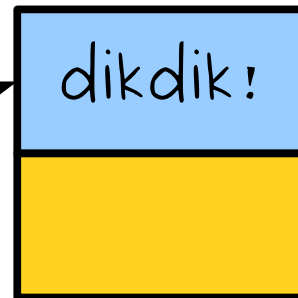
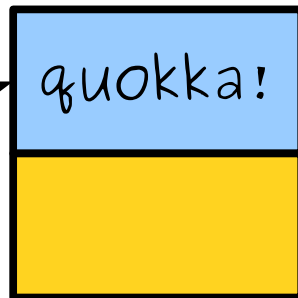
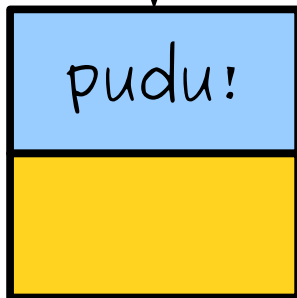

```
void deleteList(Cell* list) {  
    while (list != nullptr) {  
        Cell* next = list->next;  
        delete list;  
        list = next;  
    }  
}
```

list

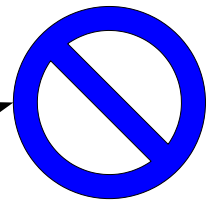
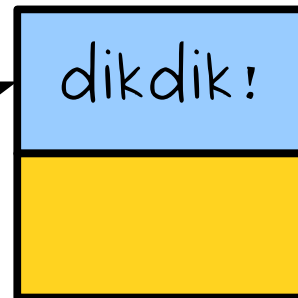
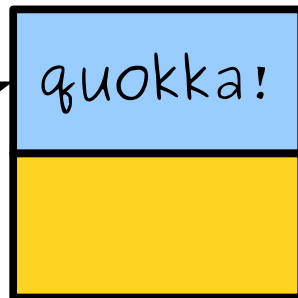
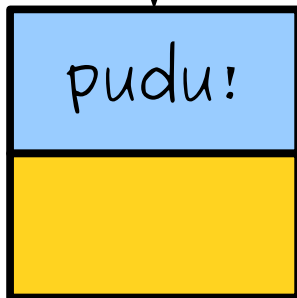

```
void deleteList(Cell* list) {  
    while (list != nullptr) {  
        Cell* next = list->next;  
        delete list;  
        list = next;  
    }  
}
```

list

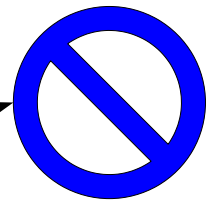
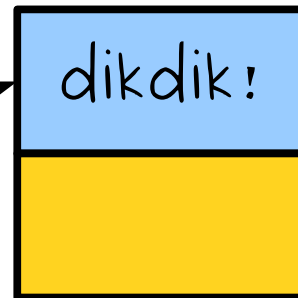
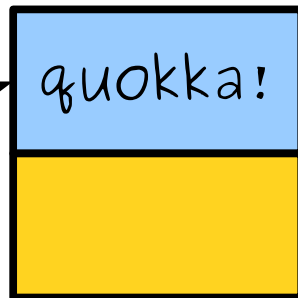
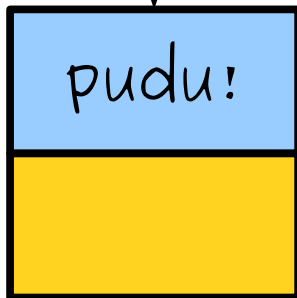

```
void deleteList(Cell* list) {  
    while (list != nullptr) {  
        Cell* next = list->next;  
        delete list;  
        list = next;  
    }  
}
```

list

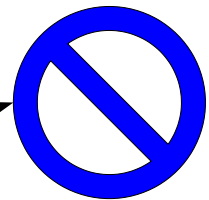
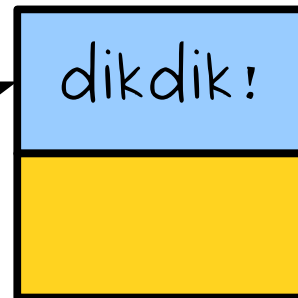
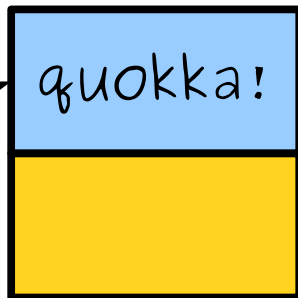
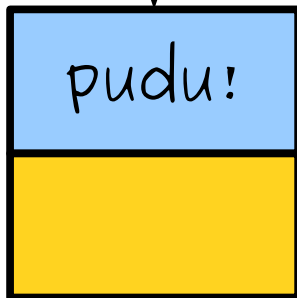

```
void deleteList(Cell* list) {  
    while (list != nullptr) {  
        Cell* next = list->next;  
        delete list;  
        list = next;  
    }  
}
```

list

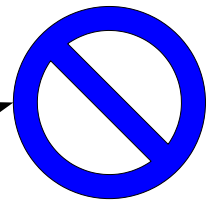
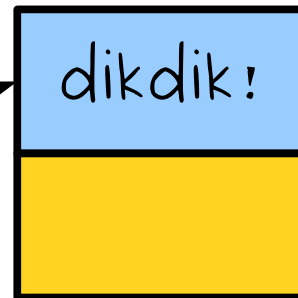
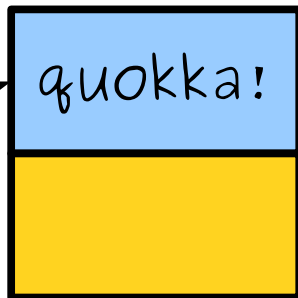
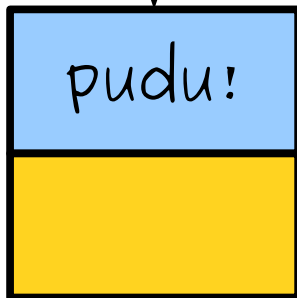

```
void deleteList(Cell* list) {  
    while (list != nullptr) {  
        Cell* next = list->next;  
        delete list;  
        list = next;  
    }  
}
```

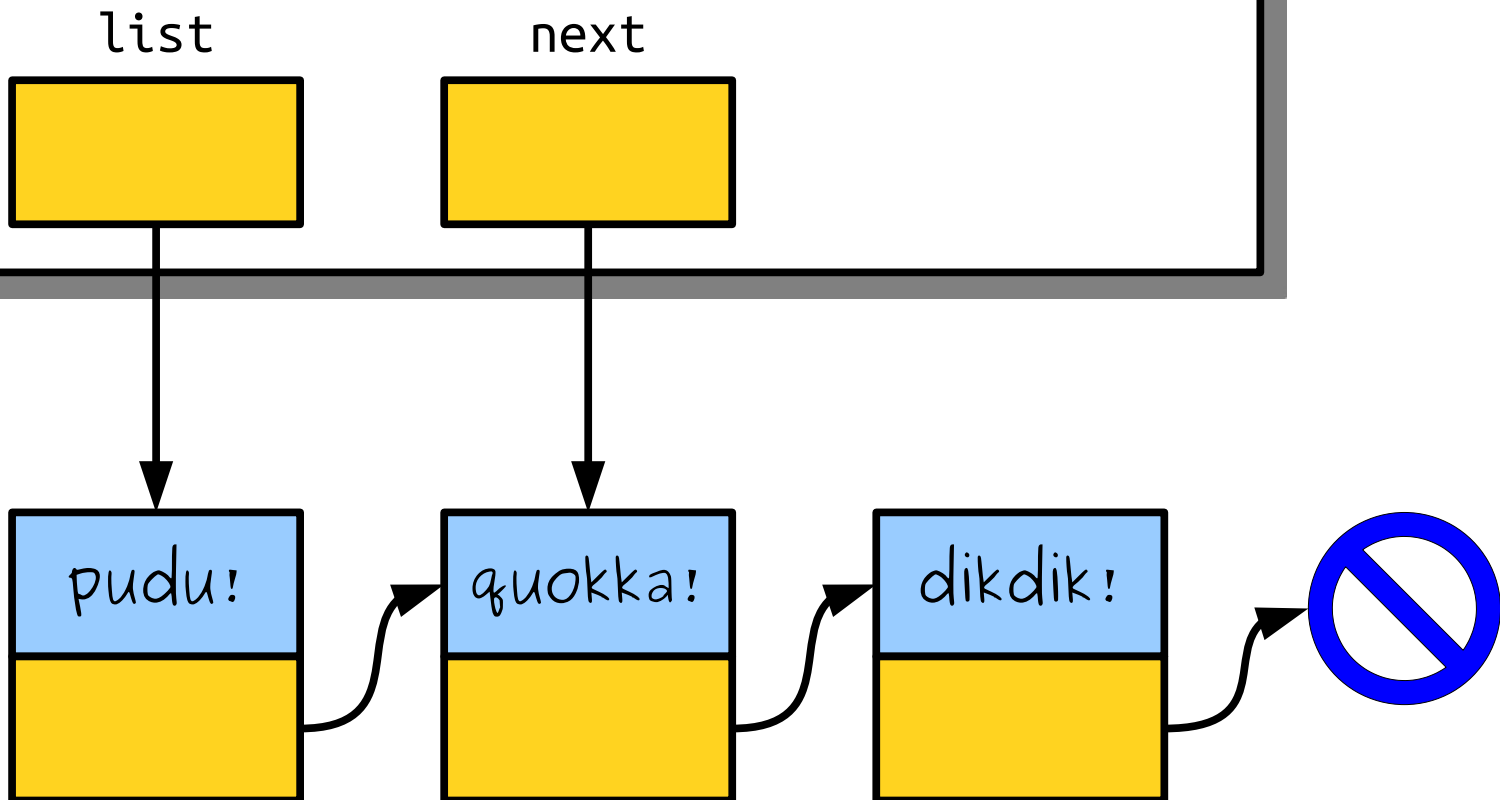

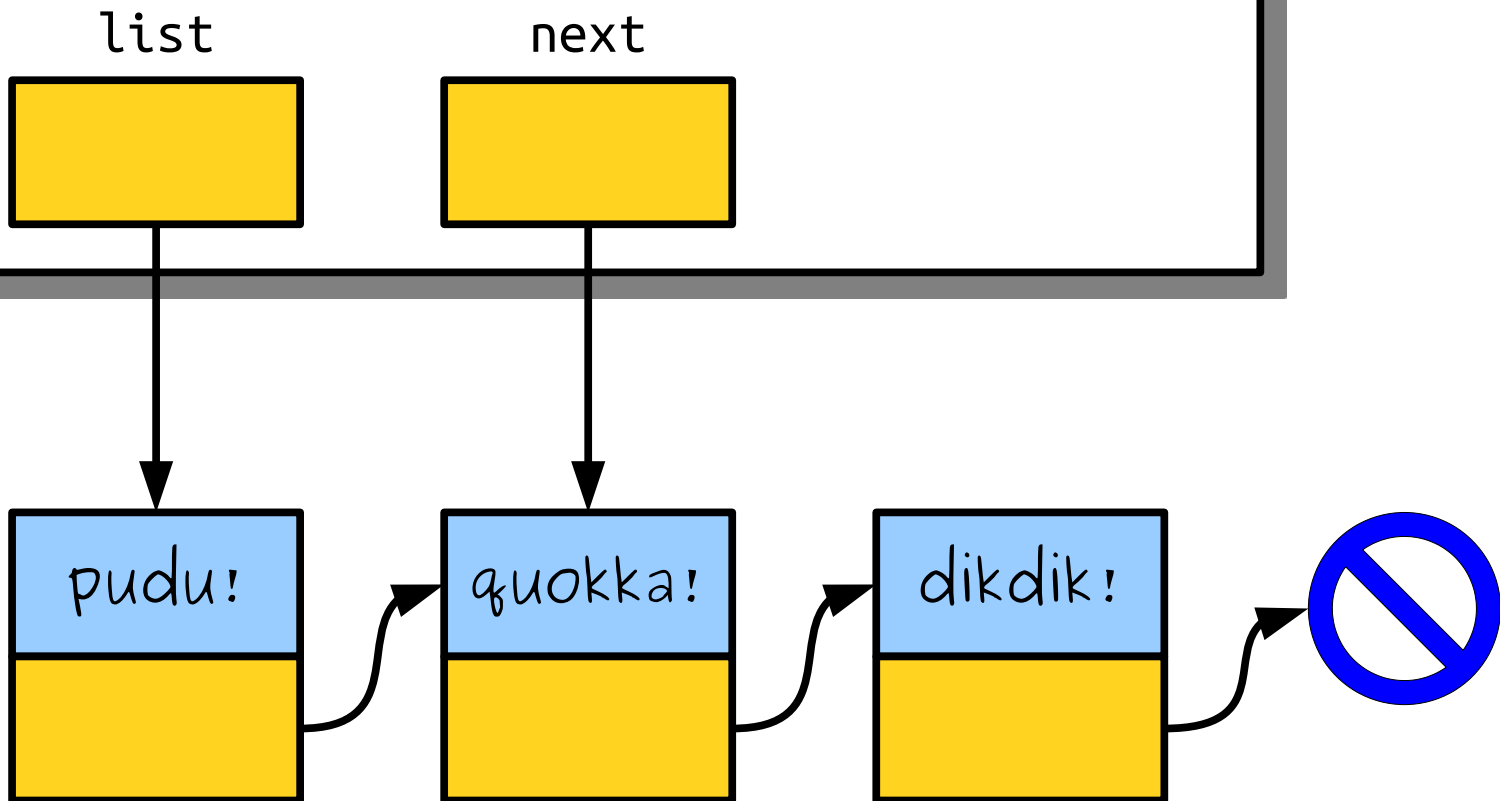

```
void deleteList(Cell* list) {  
    while (list != nullptr) {  
        Cell* next = list->next;  
        delete list;  
        list = next;  
    }  
}
```

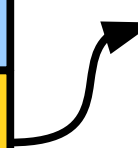
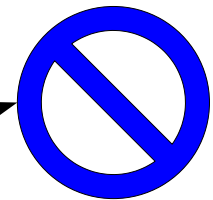
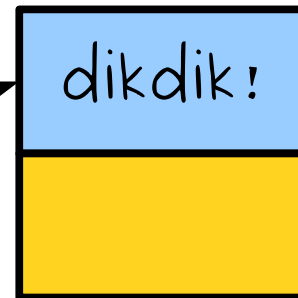
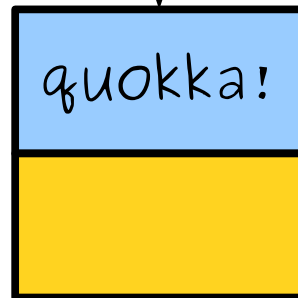
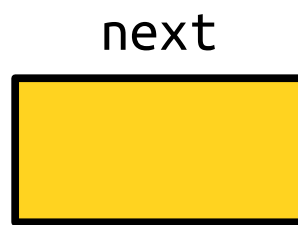

```
void deleteList(Cell* list) {  
    while (list != nullptr) {  
        Cell* next = list->next;  
        delete list;  
        list = next;  
    }  
}
```

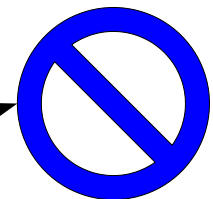
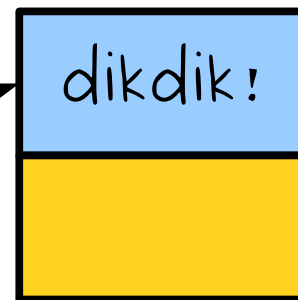
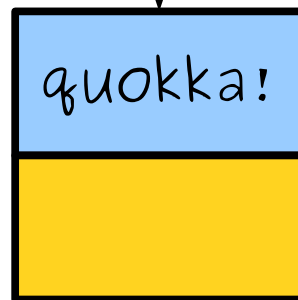
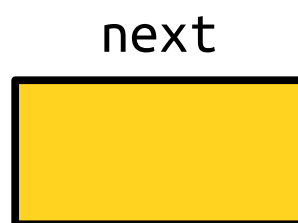

```
void deleteList(Cell* list) {  
    while (list != nullptr) {  
        Cell* next = list->next;  
        delete list;  
        list = next;  
    }  
}
```



```
void deleteList(Cell* list) {  
    while (list != nullptr) {  
        Cell* next = list->next;  
        delete list;  
        list = next;  
    }  
}
```

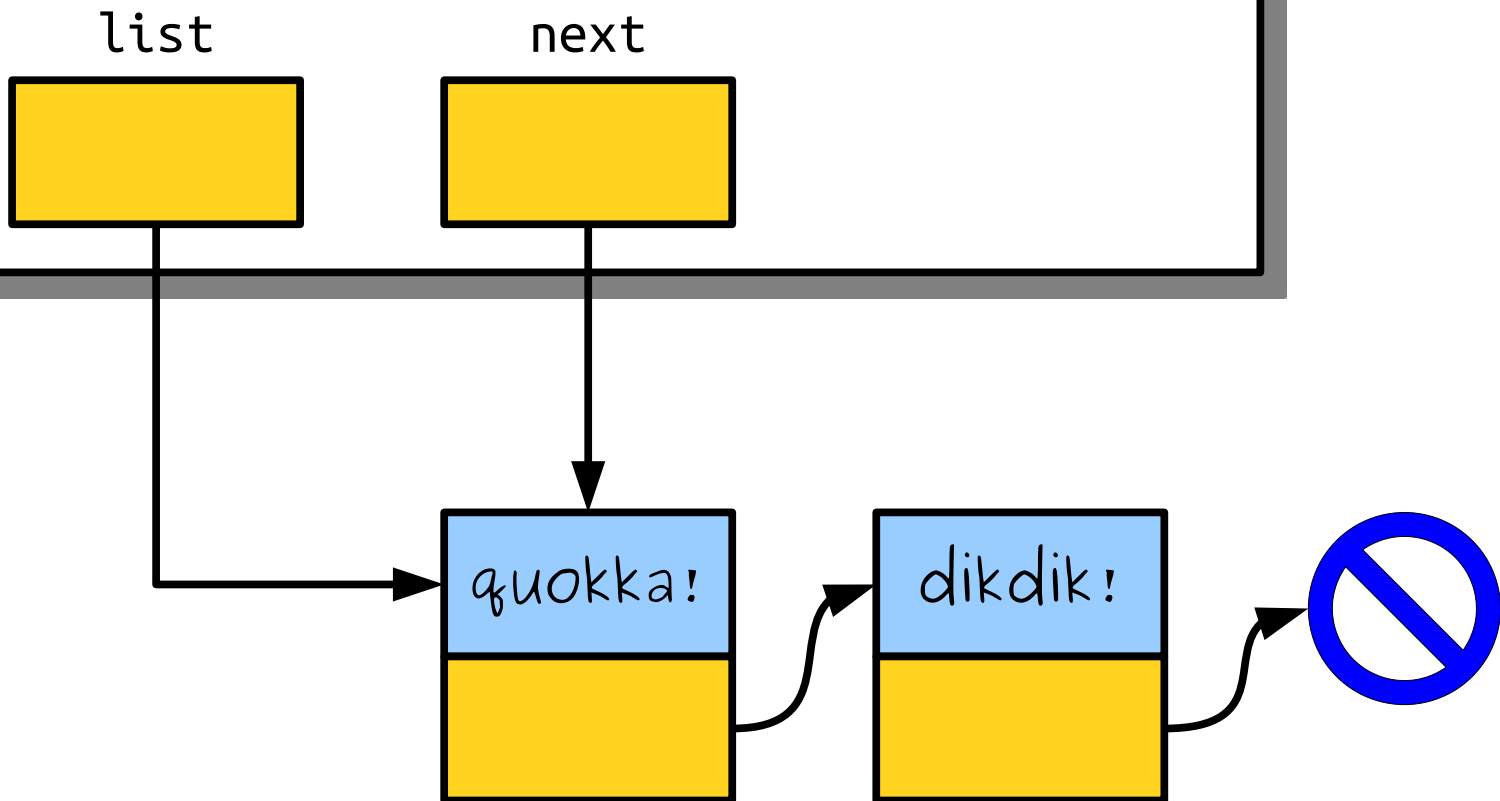

```
void deleteList(Cell* list) {  
    while (list != nullptr) {  
        Cell* next = list->next;  
        delete list;  
        list = next;  
    }  
}
```

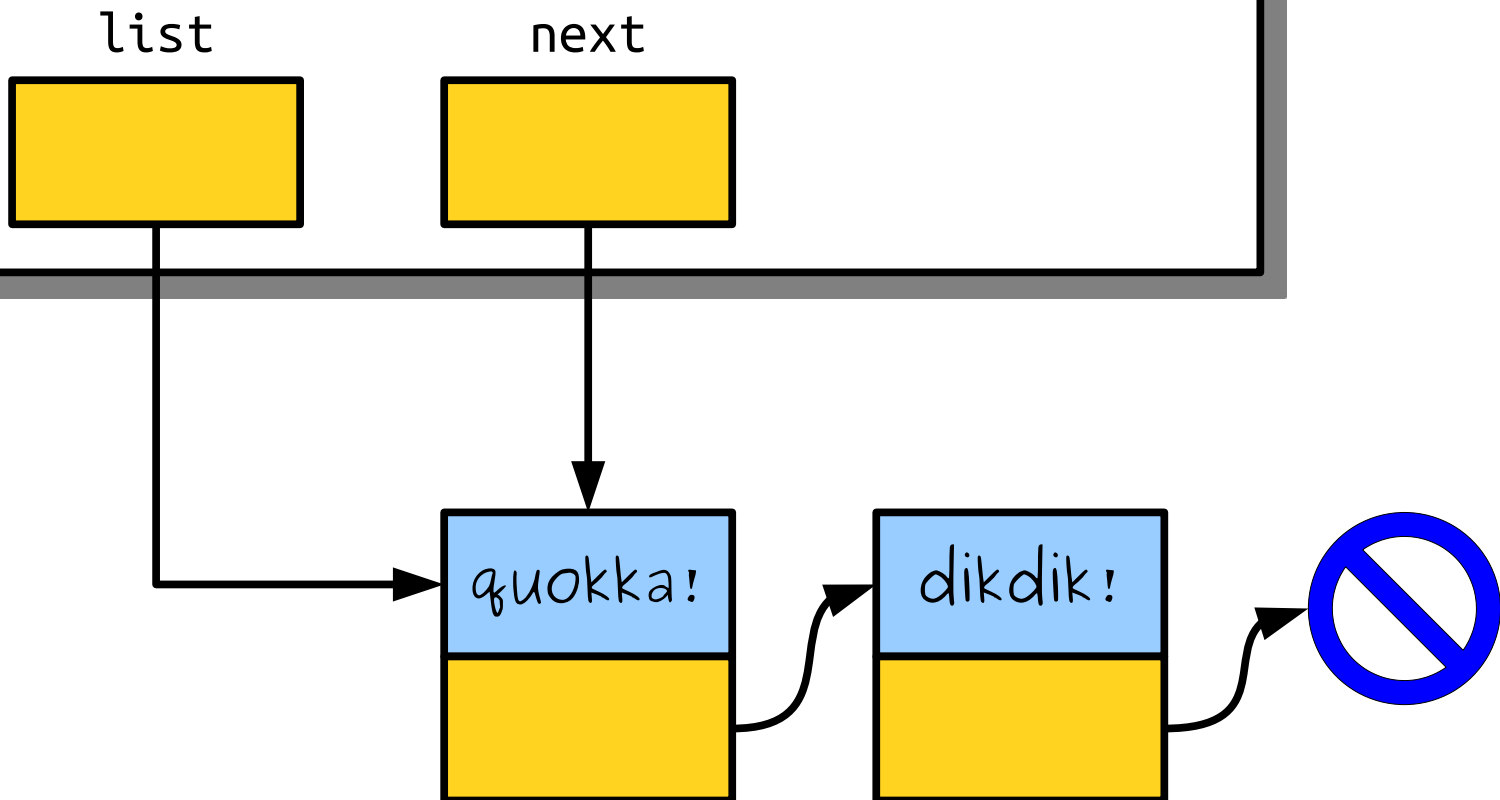

```
void deleteList(Cell* list) {  
    while (list != nullptr) {  
        Cell* next = list->next;  
        delete list;  
        list = next;  
    }  
}
```

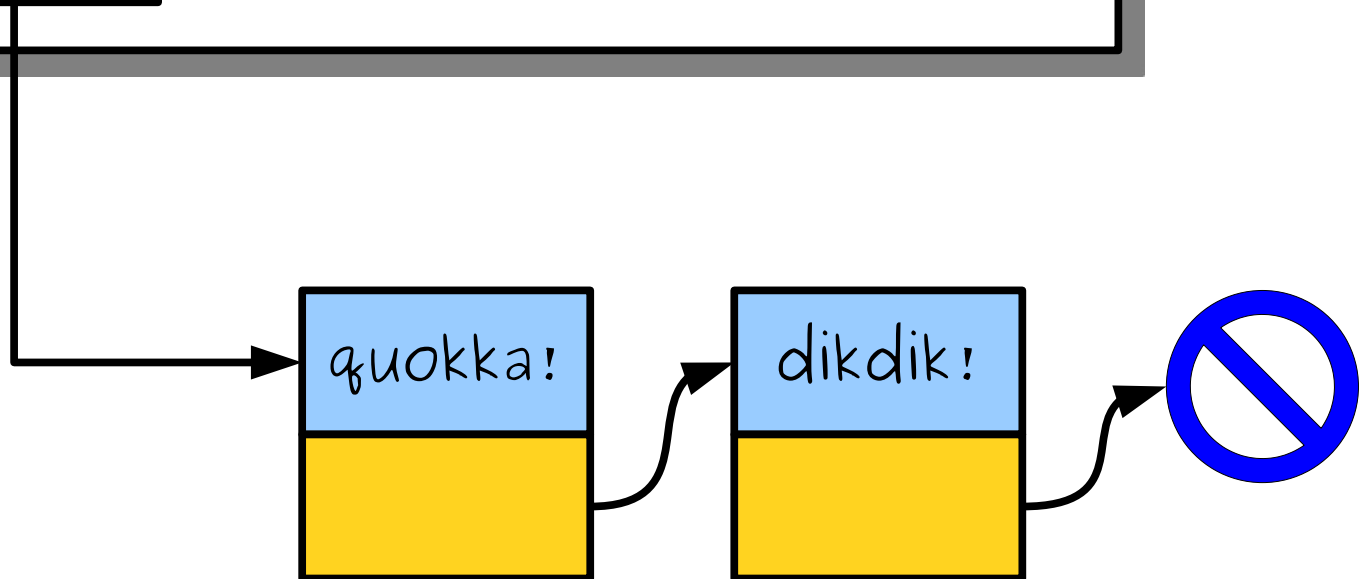

```
void deleteList(Cell* list) {  
    while (list != nullptr) {  
        Cell* next = list->next;  
        delete list;  
        list = next;  
    }  
}
```

list

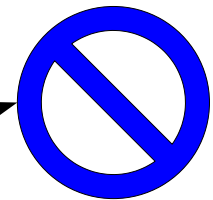
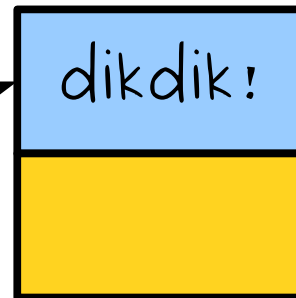
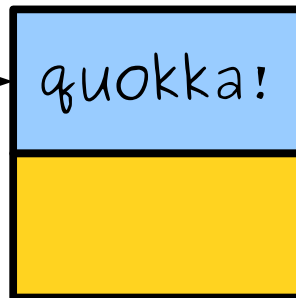

```
void deleteList(Cell* list) {  
    while (list != nullptr) {  
        Cell* next = list->next;  
        delete list;  
        list = next;  
    }  
}
```

list

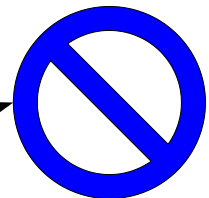
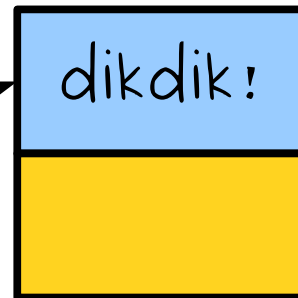
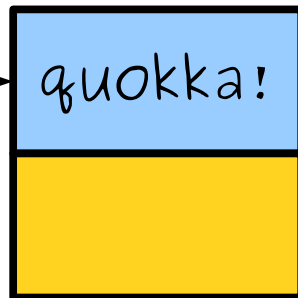

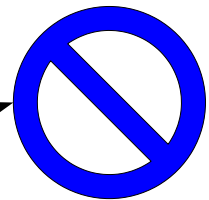
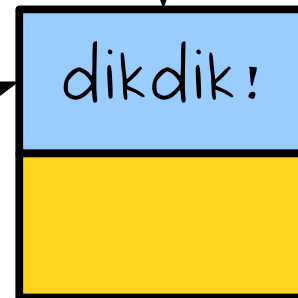
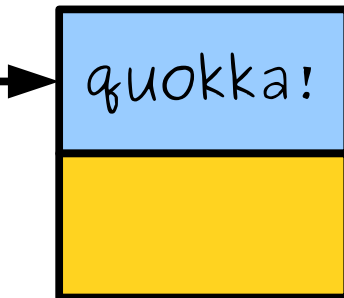
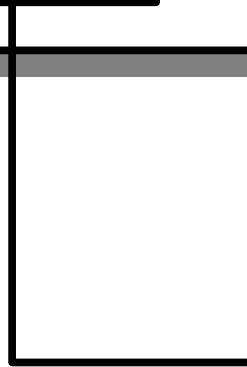
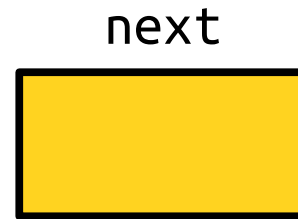

```
void deleteList(Cell* list) {  
    while (list != nullptr) {  
        Cell* next = list->next;  
        delete list;  
        list = next;  
    }  
}
```

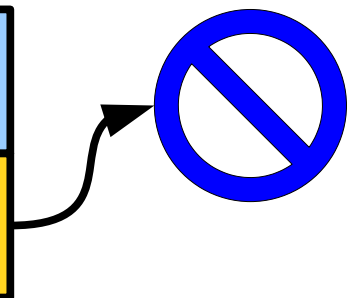
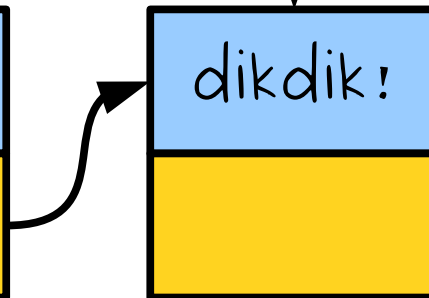
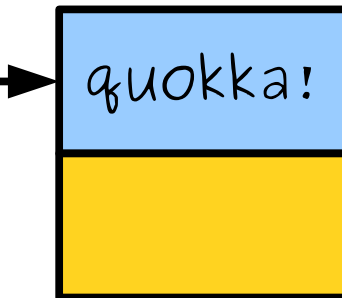
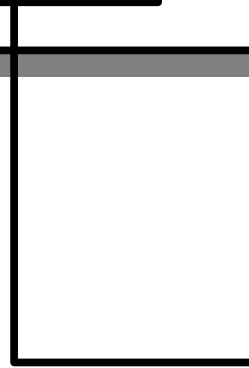
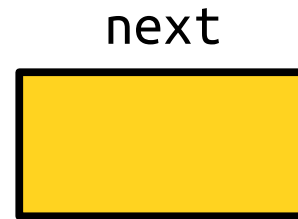

```
void deleteList(Cell* list) {  
    while (list != nullptr) {  
        Cell* next = list->next;  
        delete list;  
        list = next;  
    }  
}
```

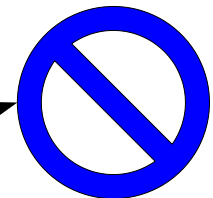
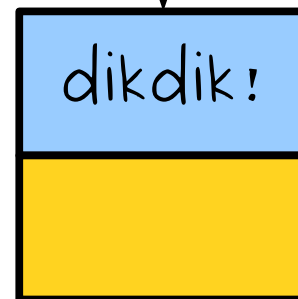
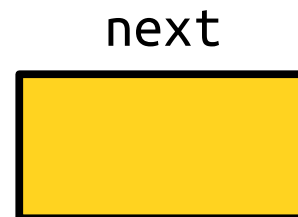
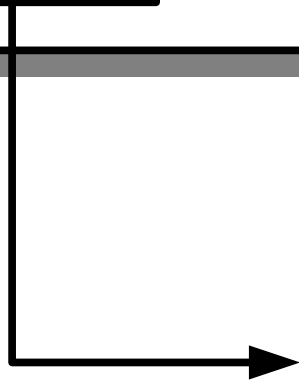
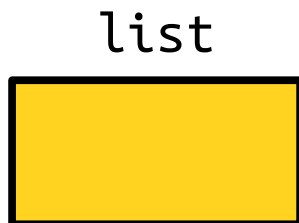

```
void deleteList(Cell* list) {  
    while (list != nullptr) {  
        Cell* next = list->next;  
        delete list;  
        list = next;  
    }  
}
```



```
void deleteList(Cell* list) {  
    while (list != nullptr) {  
        Cell* next = list->next;  
        delete list;  
        list = next;  
    }  
}
```

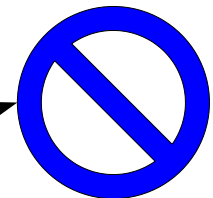
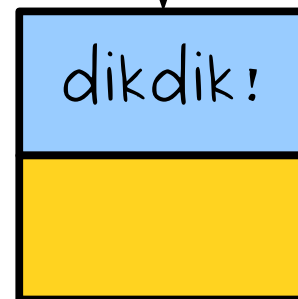
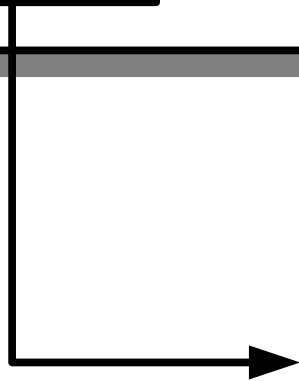
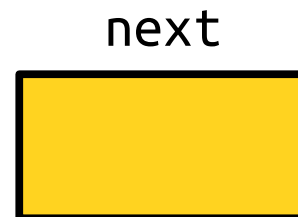

```
void deleteList(Cell* list) {  
    while (list != nullptr) {  
        Cell* next = list->next;  
        delete list;  
        list = next;  
    }  
}
```

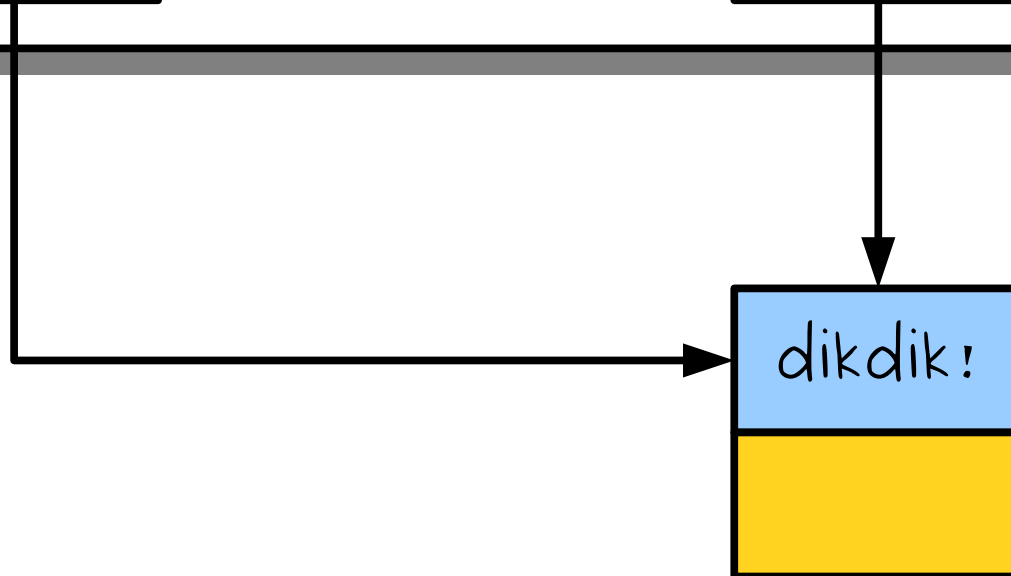
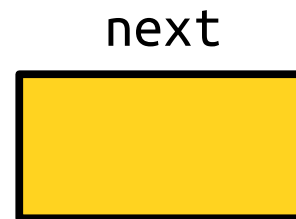
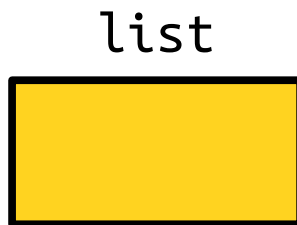

```
void deleteList(Cell* list) {  
    while (list != nullptr) {  
        Cell* next = list->next;  
        delete list;  
        list = next;  
    }  
}
```

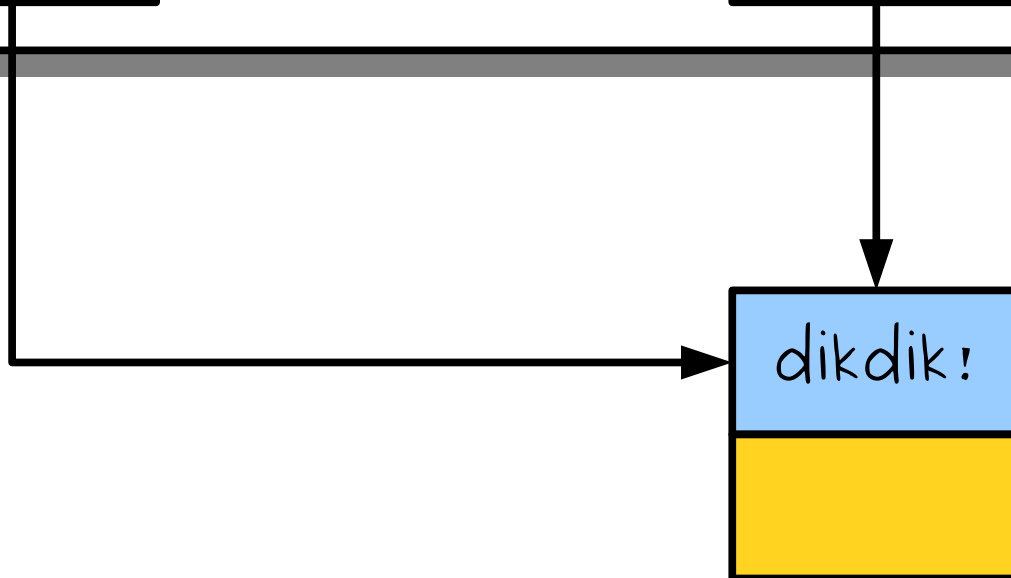
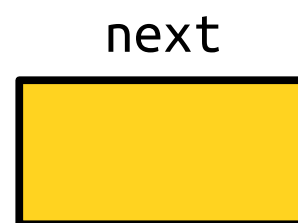
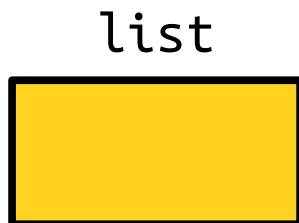

```
void deleteList(Cell* list) {  
    while (list != nullptr) {  
        Cell* next = list->next;  
        delete list;  
        list = next;  
    }  
}
```

list

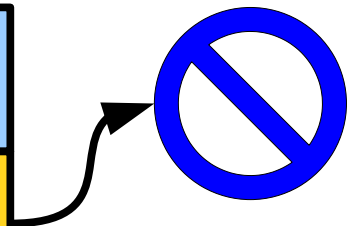
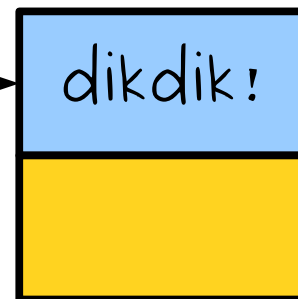
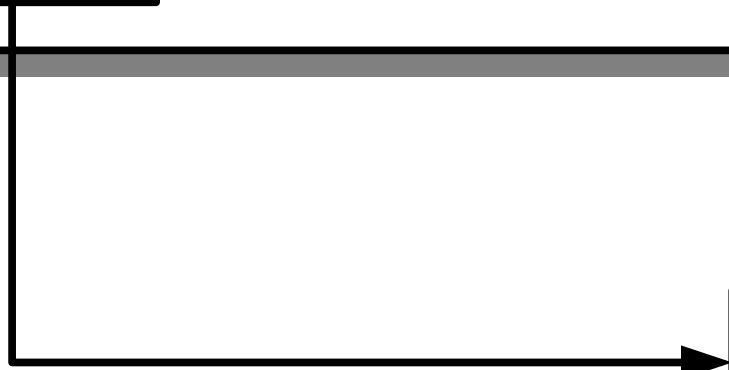

```
void deleteList(Cell* list) {  
    while (list != nullptr) {  
        Cell* next = list->next;  
        delete list;  
        list = next;  
    }  
}
```

list

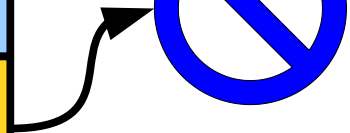
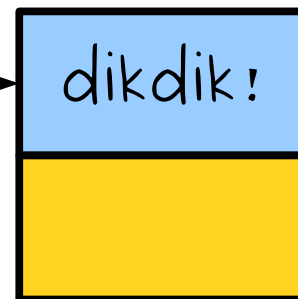
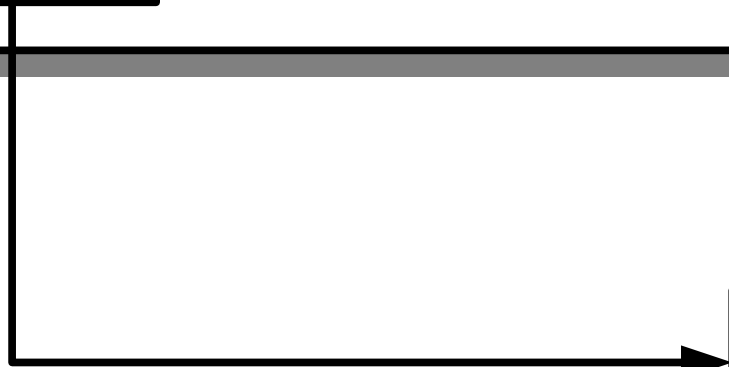

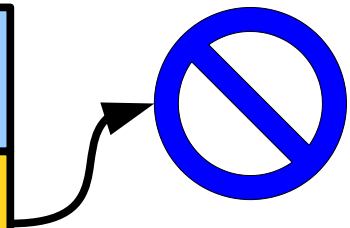
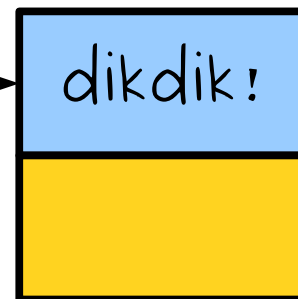
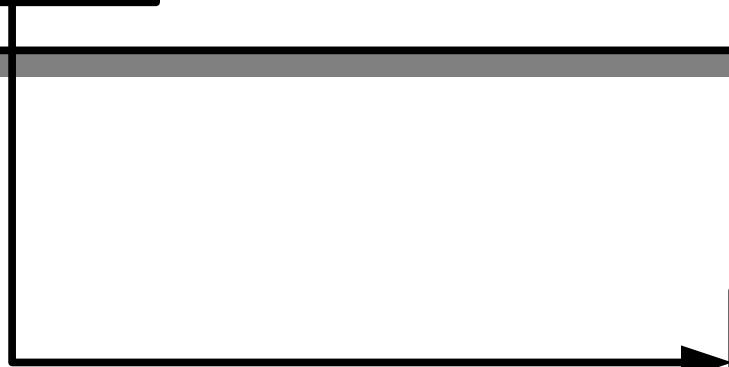

```
void deleteList(Cell* list) {  
    while (list != nullptr) {  
        Cell* next = list->next;  
        delete list;  
        list = next;  
    }  
}
```

list

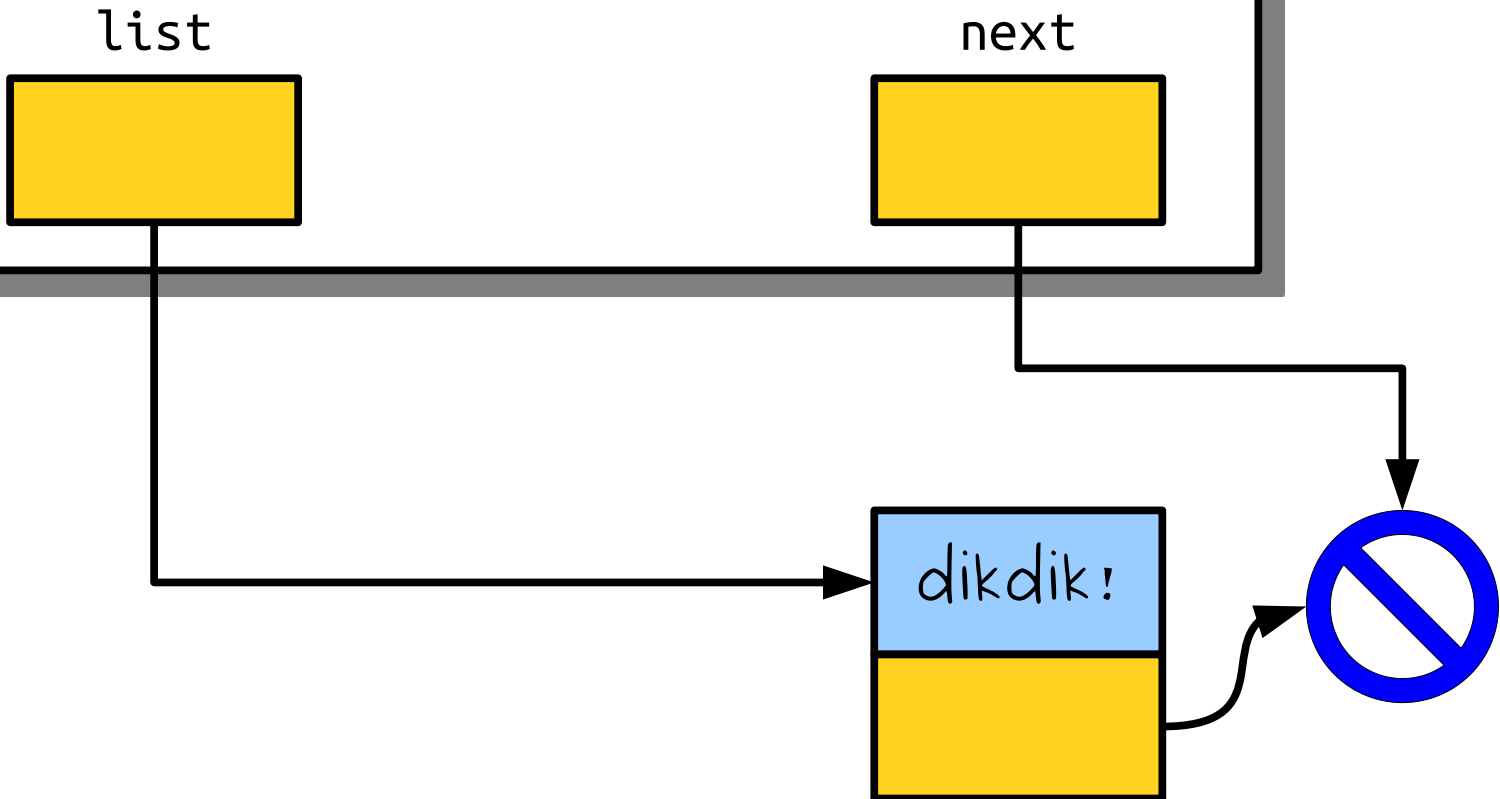

```
void deleteList(Cell* list) {  
    while (list != nullptr) {  
        Cell* next = list->next;  
        delete list;  
        list = next;  
    }  
}
```



```
void deleteList(Cell* list) {  
    while (list != nullptr) {  
        Cell* next = list->next;  
        delete list;  
        list = next;  
    }  
}
```

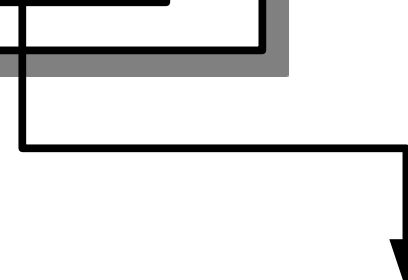
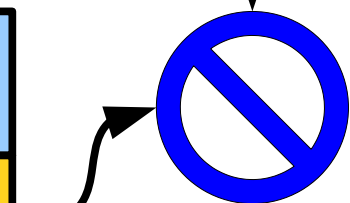
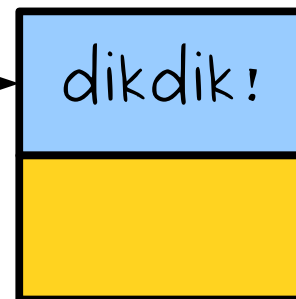
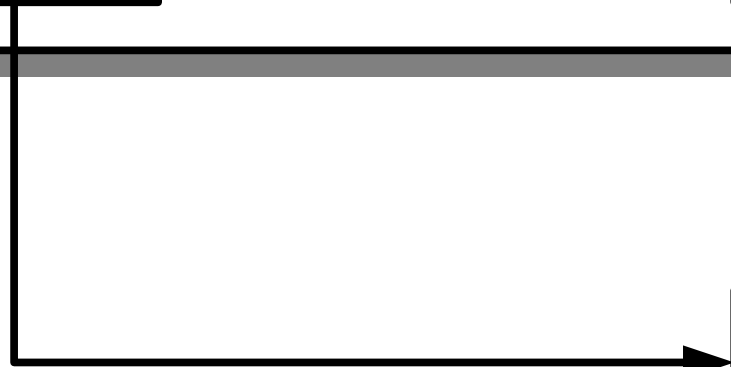
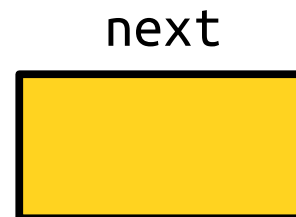

```
void deleteList(Cell* list) {  
    while (list != nullptr) {  
        Cell* next = list->next;  
        delete list;  
        list = next;  
    }  
}
```

list



next

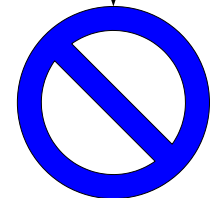
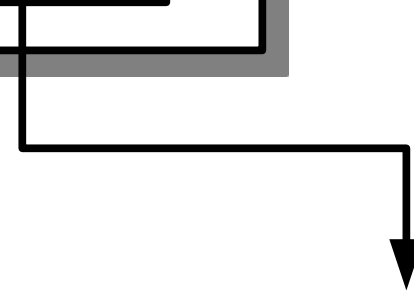
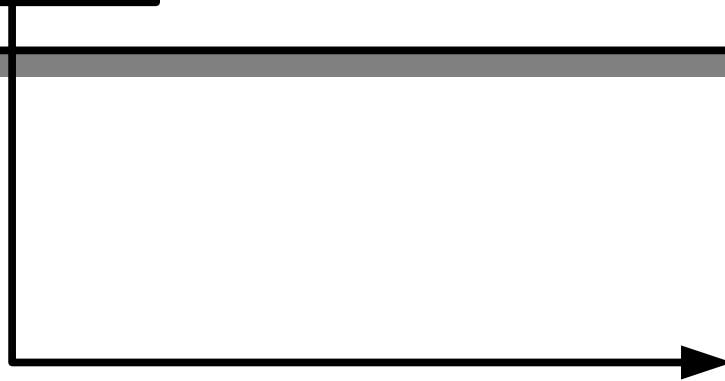

```
void deleteList(Cell* list) {  
    while (list != nullptr) {  
        Cell* next = list->next;  
        delete list;  
        list = next;  
    }  
}
```

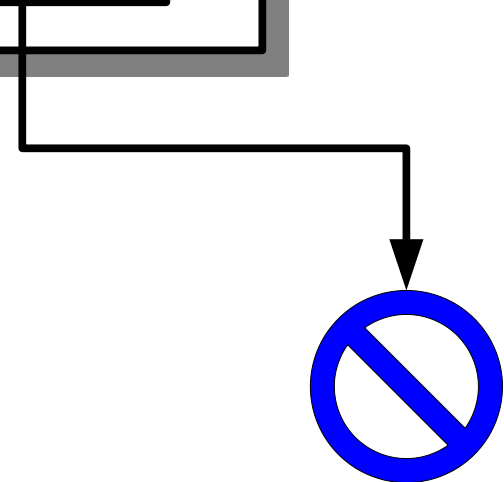
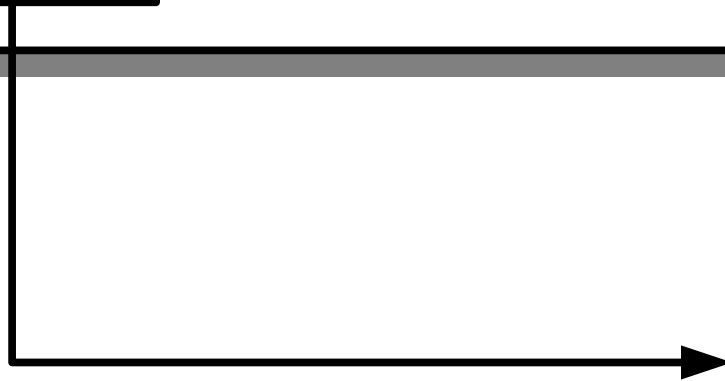
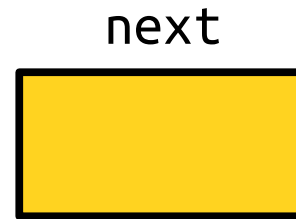

```
void deleteList(Cell* list) {  
    while (list != nullptr) {  
        Cell* next = list->next;  
        delete list;  
        list = next;  
    }  
}
```

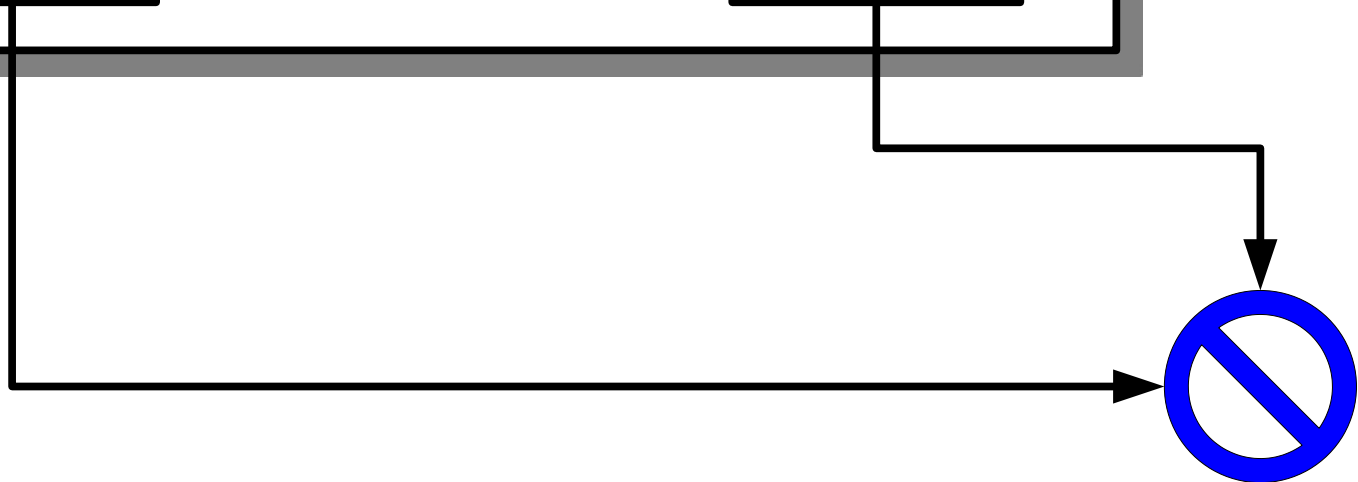
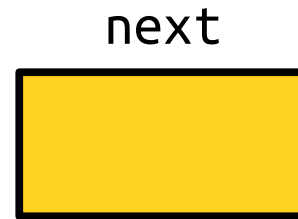

```
void deleteList(Cell* list) {  
    while (list != nullptr) {  
        Cell* next = list->next;  
        delete list;  
        list = next;  
    }  
}
```

}

list



next

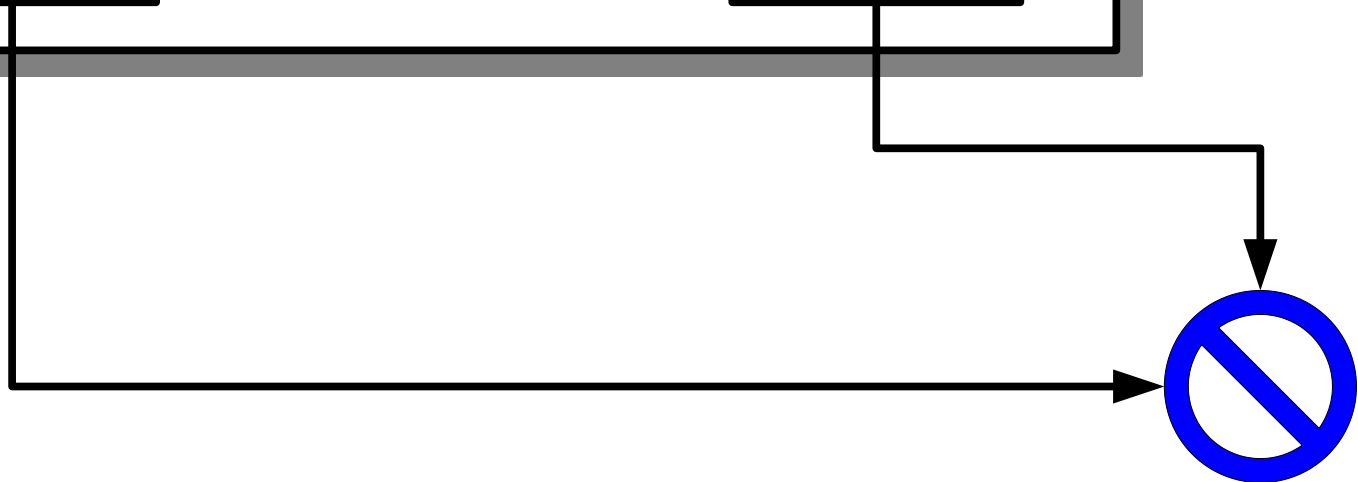

```
void deleteList(Cell* list) {  
    while (list != nullptr) {  
        Cell* next = list->next;  
        delete list;  
        list = next;  
    }  
}
```

list

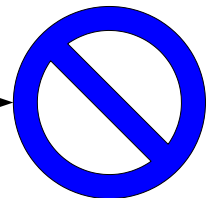
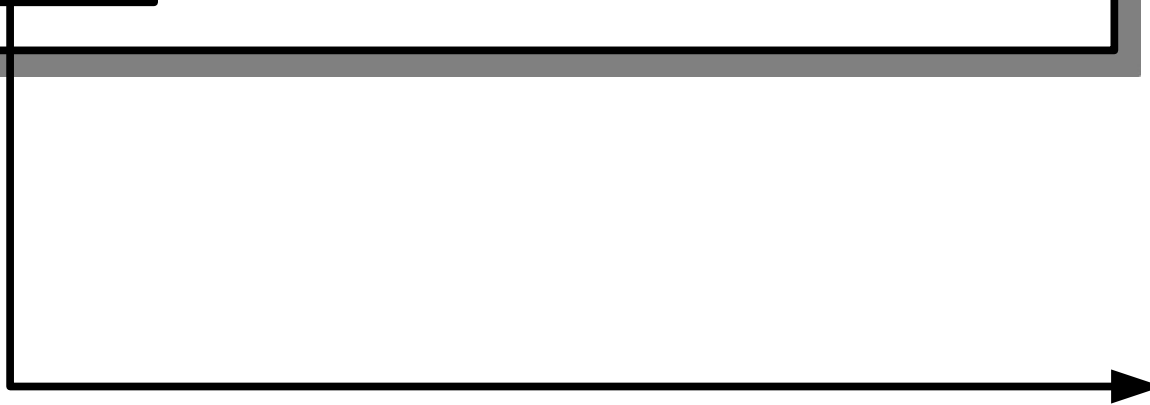

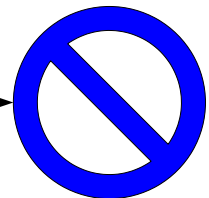
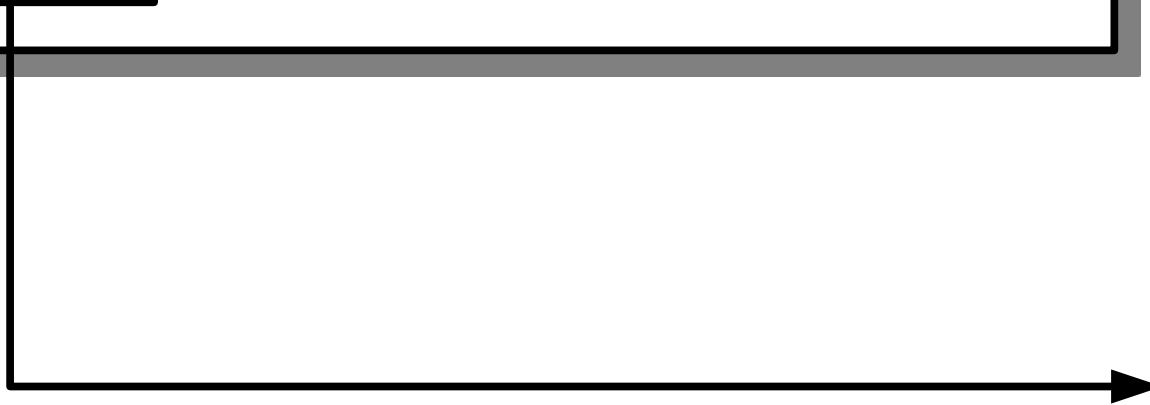

```
void deleteList(Cell* list) {  
    while (list != nullptr) {  
        Cell* next = list->next;  
        delete list;  
        list = next;  
    }  
}
```

list

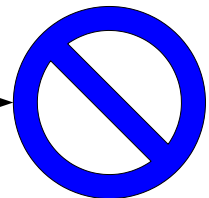
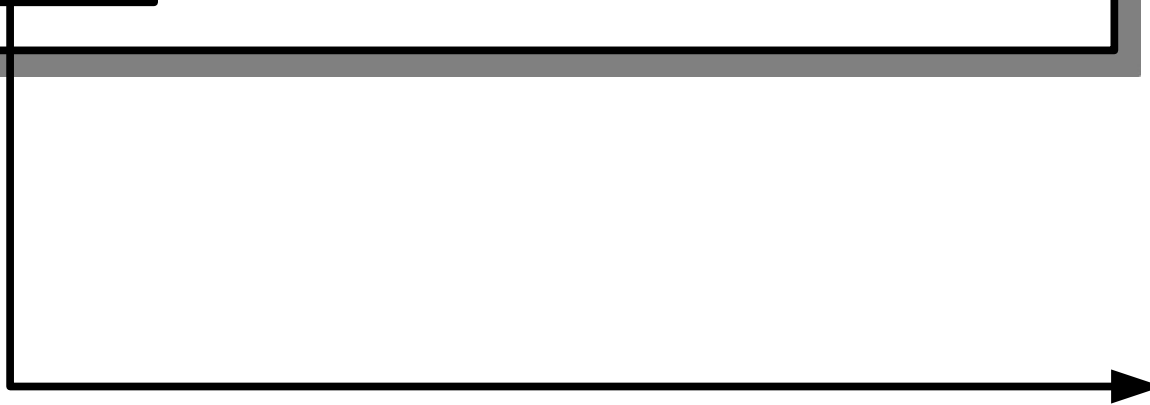

```
void deleteList(Cell* list) {  
    while (list != nullptr) {  
        Cell* next = list->next;  
        delete list;  
        list = next;  
    }  
}
```

list



Pointers Into Lists

- When processing linked lists iteratively, it's common to introduce pointers that point to cells in multiple spots in the list.
- This is particularly useful if we're destroying or rewiring existing lists.

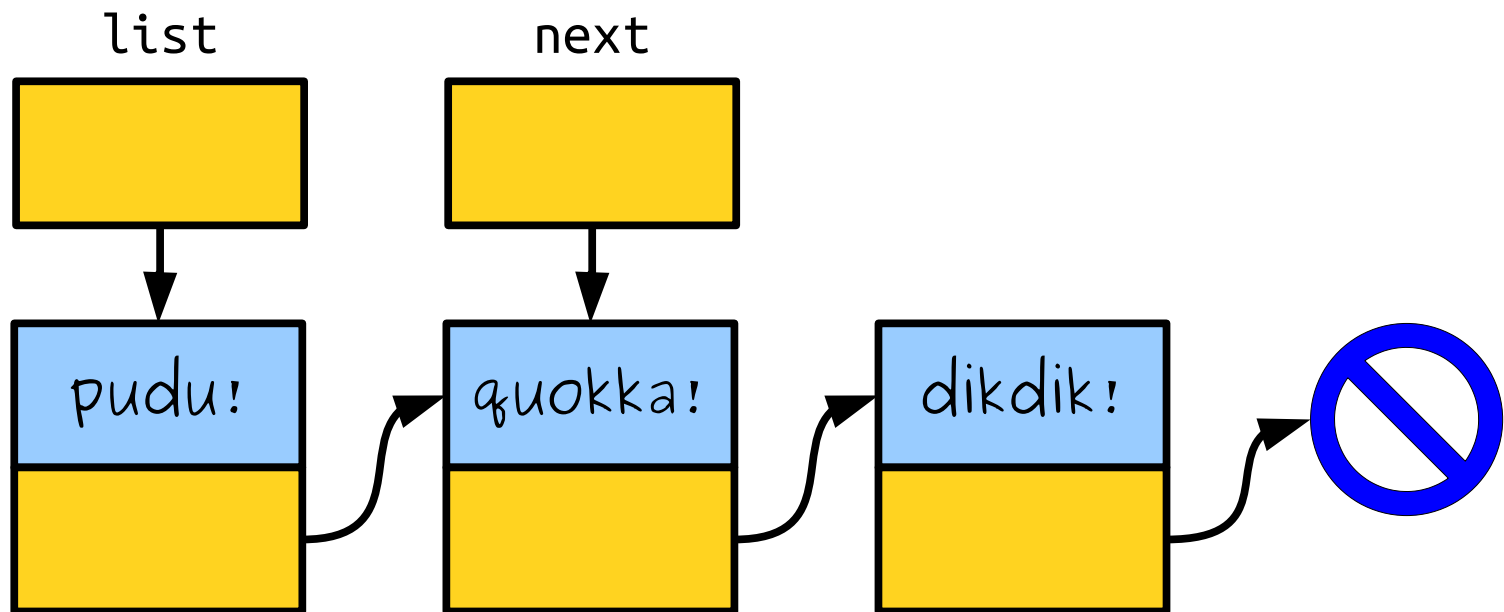

Your Action Items

- ***Read Chapter 12.1 - 12.3.***
 - There's lots of useful information in there about how to work with linked lists.
- ***Keep Working on Assignment 6***
 - If you're following our suggested timetable, you'll have finished the Enumerations Warmup and Linear Probing Warmup by now. Aim to complete Implementing Linear Probing by Wednesday if you can.
 - As always, come talk to us if you have any questions!

Next Time

- ***Pointers by Reference***
 - Getting a helping hand.
- ***Tail Pointers***
 - Harnessing multiple pointers into a list.